

COMER

\$3.95

Vol. 24, No. 10 • OCTOBER 2012

CONTENTS

- 3 The Proper Canadian Nationalism is Ethical
- 6 Metaphor!
- 11 Disaster, Data Loss and the Cloud
- 12 The Campaign for Peace and Democracy
- 13 "A New type of Distinct Society" or "A New Kind of Politics?"
- 14 Silent Weapons for Quiet Wars
- 20 Look In Your Mirror

Publications Mail Agreement No. 41796016

Spain's Leader Fails to Reach Deal with Catalonia

By Raphael Minder, The New York Times, September 21, 2012

Madrid – Spain's prime minister, Mariano Rajoy, already under pressure from his European counterparts to clean up Spain's banks and public finances, failed on Thursday to ease what has recently turned into his biggest domestic political challenge – a separatist push by the nation's most economically powerful region, Catalonia.

Catalonia's leader, Artur Mas, accused Mr. Rajoy of losing a "historic opportunity" to safeguard the relationship between his region and the rest of Spain, after they could not reach agreement on a new tax revenue redistribution plan. Mr. Mas warned that Mr. Rajoy's refusal to negotiate any tax changes was likely to increase resentment toward the Madrid government among Catalans, especially after hundreds of thousands of them gathered for a pro-independence rally in Barcelona on September 11, the anniversary of a Catalan defeat at the hands of Spanish troops in 1714.

"The people and society of Catalonia are on the move, as we have seen on September 11, and not willing to accept that our future will be gray when it could be more brilliant," Mr. Mas said at a news conference here.

Just as Mr. Rajoy's government finds itself on the front lines of the euro crisis, Catalonia, which accounts for almost a fifth of Spain's economic output, has moved to the fore of Mr. Rajoy's domestic challenges.

"The demands from Catalonia have developed a lot faster than anybody expected," said Jordi Alberich, director general of the Cercle d'Economia, a Barcelona business organization. "A difficult crisis situation for Mr. Rajoy has just now got a lot more complex."

Mr. Mas insisted on Thursday that his fallout with Mr. Rajoy was not only over

taxation and money. Yet Spain's deepening recession and budget cuts have helped shift separatism from fringe to mainstream thinking among Catalan politicians and business leaders.

As fears over a breakup have expanded in the national consciousness, King Juan Carlos, in an unusual political foray, this week wrote a letter urging national unity, which was posted on the royal palace's Web site.

Mr. Rajoy did not make any statement after Thursday's meeting with Mr. Mas. A day earlier, however, he called on Spaniards to close ranks in the midst of a crisis. "This is not the moment to generate more problems or political instability," he told Parliament.

The relationship between Mr. Rajoy and the nation's regions, which have had their own budget dramas, was already strained because of the economic crisis and his insistence that they display greater fiscal discipline in return for emergency help.

"The effort that the central government is making in terms of reducing spending is inferior to what it is asking the regions to make," Mr. Mas argued Thursday. "The sacrifice that must be done must be shared

Continued on page 2



COMER Email Update

COMER is updating its confidential email contact list to better inform members and Economic Reform subscribers of relevant, late-breaking news and local events.

Interested parties are encouraged to send a message immediately to "COMER Email Update" cnic@on.aibn.com from their preferred email account. As ever, all preferences will be respected.



FOUNDING EDITOR

John Hotson 1930–1996

PUBLISHER–EDITOR

William Krehm

(comerpub@rogers.com)

INFORMATION SECRETARY

Herb Wiseman (herbwise@cogeco.ca)

Economic Reform (ER)

(ISSN 1187-080X) is published monthly by COMER Publications

27 Sherbourne Street North, Suite 1

Toronto, Ontario M4W 2T3 Canada

Tel: 416-924-3964, Fax: 416-466-5827

Email: comerpub@rogers.com

Website: www.comer.org

COMER Membership: Annual dues

(includes *ER* on request plus 1 book of your choice): CDN\$50

Economic Reform Subscription only:

One year, 12 monthly issues, in Canada

CDN\$30, Foreign CDN\$40

Send request and payment to:

COMER Publications

27 Sherbourne Street North, Suite 1

Toronto, ON M4W 2T3

ER Back Issues: CDN/US\$4, includes

postage; additional copies same

issue, \$2; additional issue same order,

\$3. Send requests for back issues to

Herb Wiseman, 69 Village Crescent,

Peterborough ON K9J 0A9.

Copyright © 2012

COMER Publications

All rights reserved

Permission to reproduce is granted if accompanied by:

“Copyright © 2012 COMER Publications.

Reproduced by permission of COMER Publications”

Postmaster, please send address corrections to:

COMER Publications

27 Sherbourne Street North, Suite 1

Toronto, Ontario M4W 2T3

PRINTING AND DISTRIBUTION

Watt Solutions Inc., London

Printed in Canada on recycled paper.



Spain from page 1

in a fairer and more balanced manner.”

Over the past decade, however, Catalonia’s own financial mismanagement has helped make it by far Spain’s most indebted region, with \$54 billion of the \$181 billion of debt owed by the 17 regional governments.

Unable to issue more debt to private investors or financial markets, Catalonia was forced last month to request \$6.5 billion in emergency aid from Madrid in order to meet its refinancing obligations. Catalonia’s financial plight has led an increasing number of Catalans to conclude that their recovery prospects would be enhanced by loosening, or even breaking, ties with the rest of Spain.

Mr. Mas had hoped on Thursday to persuade Mr. Rajoy to allow Catalonia to reduce its contribution to a fiscal system that redistributes part of the tax revenue to other, poorer regions. Mr. Mas said that Mr. Rajoy’s response was “a no without nuances.”

With a \$260 billion economy that is roughly the size of Portugal’s, Catalonia and its 7.5 million inhabitants – 16 percent of the Spanish population – have long been an engine for the country as a whole. The region, which has its own language and distinctive culture, blends a powerful financial services sector, led by La Caixa, the Barcelona bank, with a strong industrial base ranging from textiles and automobile manufacturing to biotechnology.

The 1992 Olympics, in part financed by the Madrid government, helped transform Barcelona into one of Europe’s most visited cities. Even in the midst of the financial crisis, the city expects to have 7.5 million tourists this year, compared with 1 million before the games.

Although Catalonia is not set to hold another regional election until 2014, the dispute with Mr. Rajoy is expected to persuade Mr. Mas to call another election before the end of the year, in the hope that his *Convergència i Unió* party could capitalize on recent opinion polls showing a rising majority in favor of independence.

But Mr. Mas has so far spoken of seeking only fiscal sovereignty rather than full independence.

“Whatever path Catalonia follows, it needs to be European and about dialogue and doing things together, either within Spain or with Spain,” he said on Thursday.

Our Comment

The tangled complications of the relations between Barcelona and Madrid cannot

be simplified into “who lent whom how much and when.” Catalans enjoy thousands of years of history. And in more recent years Catalans came far to the fore again by putting down the military rebellion in the very harbour where Catalan trading with anarchist battalions has long been strong. That put anarchism in the position of a powerful tradition from the high peak of Tibi Dabo (“I will give un to Thee” in Latin addressing the deity in His heaven to the Mediterranean Southern Coast, where anarchism again displayed its unique traditional power. The setting drastically changed when the arms embargo was declared by European powers and civil war broke out in much of Europe. For that put key power into the hands of arms providers – notably Russia and Germany and the US – which managed not only to exact high prices for the weapons they sold, but achieved political domination as well.

I was in my early twenties and a dissident Trotskyist, Max Gould, who used as *nom de guerre* B.J. Field, and I had come to Europe for the first time with a dissident Trotskyite, who had behind him a career as a stock broker and had visited Trotsky in Scandinavia. Trotsky, a devout Marxist, when in power in Russia had killed more than his share of anarchists when they rebelled in Kronstadt.

The conference that Trotsky called for in the Netherlands was poorly attended, but after Field returned to New York I stayed in Europe hitch-hiking and getting to know kindred political militants.

When I was ready to return to Barcelona I was referred to a special immigration office that led from France to the north through Aragon, as I remember, and then down to Barcelona where I remained. My contact was with the *Partido de Unidad Marxista* on the Ramblas. We were put up at what had been the German consulate before the Nazis had taken over Germany, and who had subsequently be expelled from Spain. There I joined in the activities of *POUM*, spoke on their radio station and tried to keep apace with the fast-changing international position.

I was particularly close to the editor of *La Batalla*, the *POUM* publication. After the fall of the Spanish Republic, in his exile in New York, I made modest financial contributions to his New York publishing house, where I met the widows of Trotsky and a Spanish leader. When such prominent visitors came to Spain, one of my tasks was to accompany them to the Aragon front, where a whole contingent of volunteer British

solders raised by the Independent Labour Party and Fenner Brockway was stationed. Hugo Oehler was one of these, who fled to the Aragon front.

An arms embargo had been declared by the European countries supposedly to confine the warfare, but its practical effect was to put power in the hands of the US and Russia. This was abused not only to sell armament to the Spanish government at top price, but to utilize the arms monopoly for their own ends. The numerous British volunteer troops at the northern Aragon front was now removed from there and imprisoned in Barcelona.

It was there, too, that I landed. I declared a hunger-strike in protest. They declined

to follow my example because, they said, it can ruin your health irreversibly. It didn't matter, I replied, and continued my hunger strike for a good two weeks, lying on the ground in a filthy cell, reading a book on engineering. My health had not been ruined. I was transferred to hospital and force fed. The British Independent Labour Party, who inspected my condition and arranged the transfer, undoubtedly saved my life.

It might help fill in the credible picture, if I added the following details. Fenner Brockway came to Spain with a small committee who not only looked after their contingent that had been imprisoned, but arranged for my being taken to a hospital and suffering no further abuse. I was finally released and

thrown out of the country without my clothes. The French consulate was not only awaiting me at the border with a train ticket to Paris but a modest budget to equip myself with a new wardrobe.

I stayed on in Europe for another year or so not only to be at hand for the next international conference, but to hitch-hike over much of Europe, getting to know key participants in the new Europe that was a-borning. This gave me a key reference point decades later to judge how unfair the Germans and Russians had been in distorting the achievements of modern Greece and that were written off as those of a bad debtor rather the key achievement of the new Greece just being reborn. *W.K.*

The Proper Canadian Nationalism is Ethical

By W. Robert Needham, September 2012

I found the paper original of this note in 2009. The original were the points I made at a SPUC meeting held on February 6, 2000. It is still relevant it seems. I have only tried to improve the writing and add some recent updates to relevant readings. The argument remains and, if anything, is strengthened by new readings. See for example John Ralston Saul, A Fair Country: Telling Truths About Canada (Viking Canada, 2008).

1. I develop a number of definitions and ideas associated with this sometimes-nasty word, *nationalism*.

2. But first I start with an assertion so that you know where I am heading.

3. The *assertion* has a background notion. This is that in dealing with the concept of nationalism, just as in dealing with all other social relationship questions, one must always strive to *take the high road*. Strive to do the *right and proper thing*.

4. And so the question is: Does nationalism have a right and proper definition?

5. I take it that the right and proper thing always makes for the better world. What makes for the better world always means doing what is ethical rather than unethical, or immoral. And the ethical route is to be taken *in economics as well as political and other areas* of life. It means holding positions that will stand in the face of ethical scrutiny. Injustice is to be replaced by justice.

6. Specifically this ethical positioning is a base camp from which one can try to create a world in which *the conditions for the free and full development of each person are the conditions for the free and full development of*

all persons. A practical aspect of this is that *as we pursue our individual goals we do so without doing injustice to others*. A moment's reflection and one realizes just how difficult that is to do.

7. Such is the background and the base camp to the notion of a *proper nationalism*. Now what is the assertion?

8. The *assertion* is that there is a concept that can be called *ethical nationalism*.

9. I define ethical nationalism as having two components. The first component is what has come to be called *civic nationalism*. More on this in the Canadian context in a bit.

The second component of ethical nationalism is *the priority question of justice in Capitalism*. The term priority question of justice in capitalism refers to the ethics and practices implemented in coming to grips with the question of economic injustice. That is with an unjustifiable system created differentials in economic opportunity and with other end results that differentially confront other wise equal Canadian citizens.¹ [If we are equal, as we are supposed to be, why are we not fully equal? Why are systemic unjustifiable differentials allowed to persist?] The economic and social system by definition and in its operation systemically creates injustices and so it, the system, is unjust. I take it that we have a moral obligation to make the world just. So at its root what is wrong with the system?

10. There is a corollary to the assertion. The corollary is that an *ethical domestic or at-home nationalism* can only be complete if the ethical argument applies both nation-

ally and internationally. That Canadians are citizens of the world, part of the human community, implies that we have a moral obligation to struggle to assure that injustices abroad are turned into justice there just as we take on similar struggles here at home.

11. To develop this assertion I want to distinguish between other types of nationalism.

12. The first two are visceral nationalism and community minded nationalism.

13. *Visceral nationalism* is for example, the nationalism of Nazi Germany. It is a negative concept of racial superiority, of exclusion of some groups of people from full-life based on their ethnicity, color and-or religious background. Visceral nationalism generates unjustifiable inequalities in the treatment of people independently of the economic system and it is clearly immoral. Think of Kosovo, Ireland, various countries in Africa, current injustices in Syria created by the Assad regime.

14. One would hope that visceral nationalism is not a possibility in Canada. Our great diversity would seem to make it not possible.² In any event it is a concept inconsistent with our traditions and with the Canadian Charter of Rights and Freedoms found in section 34 of the *Constitution Act* of 1982. But we are still left with differentials in the treatment of people that cannot be justified.

15. *Community-minded nationalism*: Charles Taylor, Canadian Philosopher and political scientist at McGill defined it as "as sense of the significance of what a people is doing [or can do] together, of its collective

achievements and its common goals.”³ This could apply to Canada and to Quebec, one with or without the other. It could apply to Quebec outside of Canada as much as it is meant to apply to Canada, that is to say Canada including Quebec.

16. Taylor also noted the features of community minded nationalism in Canada: (1) “...To develop the five great regions as full-scale societies...the principal aim of uniting these diverse regions into one body politic can only be their combined development...a goal which would mean a fuller and more prosperous life for the vast majority of Canadians.” (2) “...To develop a mode of existence where different cultures can grow and be fully themselves without paying the price of isolation, while helping, that is, to enrich each other...a society in

which diversity is welcomed as richness and not feared as the prelude to division....” (3) “...Once we exist as a country we cannot avoid our obligation to play a role in the international scene...a strategic role in the attempt to preserve peace.”⁴

It is possible to raise questions, perhaps quibbles, about what Taylor says. For example in his point (1) why not say a more prosperous life for “all Canadians” rather than the vast majority of Canadians. And in his (2) why not say “the full and free development of each person” – is that what his words *fully themselves* means? And again in point (2) the words are meant to apply to Canada, but it seems they ought also to apply to Quebec outside Canada – but if Quebec is outside Canada has Canada and Quebec failed to achieve Taylor’s second specifica-

tion? And in point (3) his international role is peace. But in my ethical nationalism the international role is a broader more encompassing concept in that it includes economic justice. So I think it is possible to say that the words used or language with which Taylor chooses to express his ideas ignore the economic and in consequence seem to have a systemic equation of liberalism = capitalism and a disguised trickle down theory of income distribution.

17. But to be generous, the definition of community-minded nationalism and Taylor’s 3-point elaboration of it in the Canadian context is probably consistent with the civic and the international components of my assertion about ethical-nationalism; or at least can be made to be. But it seems not at all clear that Taylor even implicitly recognizes the priority question of justice within Capitalism. And so, by one of my definitions, it is incomplete; Taylor has not gone far enough.

18. This is not to say that Charles Taylor does not recognize the ethical question of justice and injustice in capitalism. But when I raised this question with him a few years ago (1993) at his lectures at Wilfred Laurier University,⁵ he retorted: “there are worse systems than capitalism.” As I see it this response, in a sense missed the point about moral obligation even as it implicitly granted the point that capitalism is unjust, and this means, I take it, that Taylor has granted the validity of my criticism of his language.

19. But some further definition of the extra-economic side of the argument. The Fall 1999 issue of *Cité Libre*, contains an article by Max Nemni⁶ of Laval University in Quebec City. Nemni distinguished between two nationalisms, both made in Canada, indeed both made in Quebec. The first he described as the ethnic nationalism of Quebec separatists. This has been a closed and exclusive nationalism, which seems required if one wants to secede, it involves Jacques Parizeau’s statement that “Quebec is a chicken plucker” and “Canada is the chicken to be plucked.” Parizeau later, I understand, provided the caricature of Canada as a cow being milked by Quebec, I leave it to you to decide whether the ethnic nationalism of the BLOC and of the Parti Québécois can be labeled visceral.

20. The other nationalism that Nemni sees as originating in Quebec is the “civic Nationalism” which he ascribed to Pierre Trudeau. Civic nationalism implies an open and inclusive society based on equal-

Letter to the Editor

Dear friends at COMER,

As I continue my own study in the field of world affairs, a book was recommended to me for reading by the name of *The Committee of 300, A Conspirator’s Hierarchy* by Dr. John Coleman. I visit your website fairly regularly and have registered with COMER under the company name Baraniuk Wade Inc., and, of course, I am very much aware of your lawsuit against the Bank of Canada, et al.

In the chance that “Committee of 300” may not have come to your attention I thought I’d best let you know of a reference in the book, page 371 and area made to the “7-power conference of London in July 1931, which put the (United States) Federal Reserve System under the control of the Bank of International Settlements....” The foregoing quote is from a speech given by Congressman Louis T. McFadden, Chairman of the House Banking Committee, dated the 4th of May 1933.

To go a bit further and to quote directly from the book, “Kennedy [John F.] ordered a review of the Federal Reserve after an unknown person sent a copy of McFadden’s speech to the White House and managed to get it past his ‘advisors’ [the author is convinced they were the Committee of 300 plans], this according to new information received from intelligence sources. When the review was handed to him, and after studying it, Kennedy issued an executive order to return constitutional money to the United States. He signed Executive Order 11110 dated June 4, 1963, calling upon the Treasury to print and issue directly United States

dollars, as opposed to Federal Reserve notes, thus bypassing the Federal Reserve banks.”

The book goes on to describe events after that but suffice it to say that Kennedy was an American patriot and his reaction to his discovery of the workings of the Federal Reserve and the action he took was to remedy the situation as well as other egalitarian reforms Kennedy intended to bring forward, in addition to his intention to reach out to the Soviet Union to ensure world peace going forward, he, according to the book, paid dearly.

This particular book may be nothing more than wild conspiracy theory, however there is at least one website, THRIVE (www.thrivemovement.com), that raises identical concerns in a rather believable manner. In addition, it is getting increasingly more difficult to understand why western leaders are still stuck in “globalist” and “free trade” mode, including our own prime minister and the premier of Ontario, when it is clear that this ideology has been consistently destructive to the vast majority. When it is clear they are ignoring the desires of The People. Where are their polices of these politicians coming from, while gross social inequality and global warming on the verge of geometric progression are completely ignored?

Please, keep up the good work and do let me know your thoughts with respect to “revelation” as describe in “The Committee of 300.”

Best regards,
Reg Baraniuk, Toronto

ity rights of citizenship. In our context it also meant reinforcement of the French language in Canada. The story involved is of the struggle of Pierre Trudeau to repatriate the constitution and to embed it in the Charter of Rights and Freedoms (in Section 34 of the *Constitution Act*).

21. Let me now say a bit about Economic Nationalism. By that term I mean the Economics and Ethics of Community Survival. When I started teaching I was an economic nationalist. The way I defined economic nationalism then and still define it today runs in terms of an alternative to what the powers that be were allowing to be pressed on Canada by outside forces. This makes my notion of economic nationalism sound something like Quebec nationalism in the sense of being economic “masters in our own house.” But economic nationalism did not have and cannot have according to my definitions any ethnic component. Being economic masters meant we could at least have a democratic voice in determining the character and degree of our integration in the world economy. The alternative was capitalist imperialism or outside control. Outside control was and still is registered in foreign ownership of resources and other sectors, a branch plant structure and truncated manufacturing. Foreign ownership was seen as limiting the growth and development of Canada along lines that could have been defined by Canadians. In other words we were being put in the service of foreign corporations and our governments have assisted in this. Canadian governments have allowed capitalist development in the twentieth century to continue in the same fashion as the Hudson Bay company in a much earlier time. The sort of thing being objected to can be seen in the words Neil McElroy.

“Neil McElroy, chairman of Procter and Gamble explained, ‘It is customary in our development of overseas markets for us to use a minimum of US Capital, a maximum of borrowing overseas, and reinvestment of earnings abroad.’ You didn’t even have to bring in much to take over an industry in a place like Canada: you could borrow the money from a Canadian bank repay it with profits carved out to the Canadian price structure and waddle home with the rest. Indeed you could use the foreign subsidiary to buy from the American parent. McElroy could approve it too.... The American corporation had sent \$11 million out and brought back \$290 million, \$47 million in profit and \$243 million in purchases.”⁷

22. I could not see that that sort of thing and generally foreign ownership implied the self-determination/sovereignty that is implied by the notion of the free and full development of the individual let alone of the nation and its regions. And neither could many others, most notably I suppose, George Grant who wrote a book titled *Lament for a Nation: The Defeat of Canadian Nationalism*. Grant it can be said saw capitalism, capitalist individualism and technology as the root causes of our problems. They prevented us from pursuing the common good and, rather, they directed us to a more US style of life based on the private market and profit as the one value to be concerned about.

23. Subsequently, and consistent with market dominance, in the 1980s the citizens of this country and others have been subjected to the abuses of neo-conservative political power and economic and social policy.⁸ These have not been policies that looked to strengthen community. They have nothing at all of community-minded nationalism in them. In fact like a cancerous disease⁹ they have attacked the very

programs and institutions that make for community strength. So, like globalization, corporatism and the anti-Government notions they illegitimately spawn, they can be said to be anti-nationalist and anti-community.

24. For this reason it seems to me that the neo-conservatives have unwittingly assisted in adding a new dimension to the practical struggle against neo-conservatism itself. The struggle against neo-conservatism itself seems to unite people of every social activist description at home and abroad. The Seattle demonstrations against the WTO seem proof positive. In those demonstrations the world saw the coming together of people from the four corners of the globe to demonstrate against the WTO and the planned imposition of “freedom for capital constitutions” of the sort built into NAFTA and that would have been built into MAI, the *Multilateral Agreement on Investment*. These economic constitutions provide rights to capital over people. The demonstrators in Seattle were expressing a people’s internationalism in opposition

Letter to the Editor

The following letter to the editor was carried in The Windsor Star on September 20. The Star deleted the first one-line paragraph, “Are Canada’s leaders gofers for Wall Street?”

Are Canada’s leaders gofers for Wall Street?

Canada is the most bountiful of all the lands. Canadians should be sharing the world’s highest living standards and modern infrastructure. Rather this bounty is directed to Big Oil, private banks and top-of-heap elite.

Leadership brings more debt and taxes, declining service and a factory job wasteland.

Following WW2, Wall Street insiders put into operation their strategy for grabbing nations’ wealth, including America’s, for themselves. From Canada, they wanted only our fabulous resources and oil. A more dynamic and prosperous nation north of the US border would be an embarrassment.

“Free Trade” and “Globalization” are codewords for the takeover. It took only the simple task of gaining control of governments’ trade policy. Trade agreements handed over to Wall Street the control over Canada’s industry and jobs, and claims ahead of Canadians for resources.

Today we can watch how leaders advance Wall Street’s strategy.

The energy, education and skills of multitudes of Canadians are squandered in ranks of desperate unemployed.

Canadians sitting on the world’s richest resources are told to work for lower wages, benefits and services. Global corporations tax all Canadians through massive subsidies and tax offloads.

Ontario at constructive work would mean Canada leading the world in prosperity. Recently CAW proposed a “Fair Trade” auto industry plan. Beginning with cars, it could point a return to the prosperous days of zero sales tax, when industries mobilized world-class skills, and full employment built everything Canada needed.

For Globalizers, protecting Canadian jobs for Canadians is a nasty four-letter word. Sharing all that bounty with Canadians would be such a waste. Jeff Watson’s response: “Protectionist walls subsidized by taxpayers.” Industry expert DesRosiers to autoworkers, “They’re looking in the rear-view mirror.”

Canada produces some of the most talented and successful leaders in the world.

It’s too bad they’re not on our side.

Don Waffle, Harrow, Ont.

to capitalism and globalization that has an ethical base consistent with what they were also arguing should apply in their various home countries.

25. So I give it to you that implementation of the definition of ethical nationalism and economic justice involves nationalist policies for and of local community survival and they are necessitated by the destructive influence of unregulated markets, globalization and neo-conservative economic and social policy, including and especially, free trade and international finance.

26. Note that this provides a link from the ethical base for community survival at the domestic level to an equal ethical base for strengthening the international community. Practically this involves world governance of a sort we have not yet devised but that sits in embryo form in the United Nations and in the various charters of Human Rights to which Canada is a signatory. So, again the proper nationalism is internationalism with an ethical face.

27. I have tried to trace a conceptual scheme or ordering of ideas that I think helps to understand current events and the notion of nationalism in Canada and where we ought to be heading to progressively extend human rights and freedoms.

28. In summary, ethical nationalism means civic nationalism and it means coming to grips with the question of justice in capitalism so as to extend equal rights of economic and political citizenship to all the people of the earth. An idealistic struggle indeed!

29. One last thought is that there is another way of wording this argument. Tommy Douglas said on many occasions that in Canada we had a *political democracy* (procedural electoral rights for equal citizens) but we did not and do not have an *economic democracy*. My argument is consistent with that evaluation and goes beyond it in a way with which T.C. Douglas would agree:

*Full Democracy = Economic Democracy
+ Political Democracy
Ethical Nationalism = Economic Justice
+ Civic Nationalism*

Some Additional Readings

Frye, Northup (1982). In Polk, James (Ed.) *Divisions on a Ground: Essays on Canadian Culture*. Toronto: Anansi.

Taylor, Charles (1985). *The Agony of Economic Man*. In Forbes, H.D. (Ed.) *Canadian Political Thought*. Toronto: Oxford University Press.

Continued on page 10

END THE FOLLY IN SENSE-PERCEPTION

Metaphor!

By Lyndon H. LaRouche, Jr., September 19, 2012

From the lifetimes of such as Heraclitus, through Socrates and Plato, as through Eratosthenes, and, as in modern times, from Filippo Brunelleschi, through Cardinal Nicholas of Cusa, and such of their followers as Leonardo da Vinci, and Johannes Kepler: the true mainstream of modern science had, thus, subsequently expressed itself in the ontological realities of what had been the classical artistic principle of *metaphor*. Nicholas of Cusa, successor of Johannes Kepler's introduction of the demonstrated, metaphorical principle of *vicarious hypothesis*, has supplied the crucial basis for the competent practice of modern physical science, that, specifically, of Kepler's outstanding contributions, still today.

So much for the subject of those essential definitions. The practical issue which must be featured from that standpoint, is the fact, that human sense-perceptions, when considered as such, are merely shadows cast, mere shadows which the credulous folk substitute for "reality." That is done in place of that which is defined as truly efficient "substance." All efficient truth is located, ultimately, within the bounds of the effective intention of what is to be defined as metaphor; it is that efficient intention, when assigned to metaphor, as I have just defined it here, which is inherently, by its nature, the truly proper subject to be considered here and now.¹

The grave error which we must first consider in this report, is located in what is commonly recognized as the quality of error which is intrinsic to reliance on the notion of "sense perception as such." Such faith in "sense perception" is the typical root of an entire system of error, a type of error currently still deeply embedded in the customary general practice of sense-perception by populations generally. This custom must be strictly defined as a continuing sort of an active practice of "error," rather than the notion of being merely a particular lack of proper education. The corrected replacement for the mere notion of sense-perception, the replacement properly named "metaphor," is to be regarded as mandatory, for the reason that the correct view of the subject-matter had already been

defined in certain known, ancient cultures. Those included cultures existing prior to the certain known, ancient cultures. Those included cultures existing prior to the resurgence of a leading reductionist kind of depravity, a kind of resurgence which had become practiced under modern systems of oligarchical depravities such as the culture of the British empire-system, among other victims, still today.

Consider the most essential features of the relevant history of the foundations of modern science.

The revolutionary progress associated with the Fifteenth-century "Golden Renaissance," had reached its relatively highest rate of underlying scientific progress, under the globally extended influence of the referenced Cardinal Nicholas of Cusa (AD 1401-1464), during and beyond his lifetime. Cusa had been a most crucial thinker of his time, probably the most crucial of both his own lifetime and that of his immediate posterity from among the founders of modern science. Among his other leading achievements, Cusa was the founder of a systemic comprehension of that then newly-stated principle of physical science, an authority which is defined with precision in his *De Docta Ignorantia* ("Learned Ignorance," AD 1440), and, as this discovery by Cusa is reflected in the unique, existential principle of astrophysics, metaphor, which was to have been introduced as a discovery by Johannes Kepler.

While Cusa's seminal achievement in that and related matters, has been unique to modern science in all leading respects, his achievement must also be recognized as both a reflection, and a correction of the great earlier achievements of Plato and his circle. The significance of that part of the history of the European Renaissance for modern society today, is best typified by the unique achievements in physical science due to Johannes Kepler. Unfortunately, lately, despite the great achievement of the 1648 Peace of Westphalia, the extended practice of tyranny by the so-called "New Venetian party" of William of Orange, et al., had led modern Europe into the subsequent establishment of the British empire as an empire-in-fact, as under Lord Shelburne already in February 1763. Matters went onwards

from that earlier imperial victory of his, to emerge, soon, as the modern British Empire launched by means of Shelburne's 1782 establishment of the British Foreign Office.

The British empire, as it was established then, is still the relevant party of world empire today – a role which the British monarchy shares currently with the same Saudi Arabia which has played a key role in the mass-killing of US nationals in the so-called “9-11” incidents of 2001, and, later, the recent slaughter of US diplomatic nationals in Libya.

Those recent murders, which have been prompted by the policy of practice of President Barack Obama, reflect the pattern of frauds which some have practiced in the course of promoting such imperialist atrocities as a presently global prospect of general thermonuclear warfare. The presently immediate prospect of a war which would suddenly lead virtually, or actually to the threatened extermination of our human species, now demands an immediate institution of that specific quality of alternative order of global society, a quality, the which, by that specific quality of alternative order of global society, a quality, the which, by its very nature, eliminates the threat, but without destroying what we must now restore as the continued principle of the system of sovereign nation-states.

Those just stated facts, lead us now into the core-subject of the crucial matter so placed before us now: the matter of the little known, but truly knowable principle of the human mind. I explain, as follows.

I. The Principle of the Human Mind

The both conventional and also inherently mistaken, “popular” doctrine, which is familiar to us as the trust in “sense-certainty,” should now become recognized correctly as having been obviously absurd in principle, as it had also been virtually universal on precisely that same account. That doctrine has been a generally accepted, if nonetheless wrong belief, which had been established about “as far back” as a current “popular opinion” respecting “text,” has been enabled to reach, up to the present time.

Nonetheless, there had been significant, nobler exceptions to such misguided, or otherwise faulty opinions as those presently common among the broader strata of populations. I mean the exceptions among those rarer minds which had been developed to a higher degree, associated with what had been commonly known, formally, as rooted in truly Classical modalities in music and

poetry. Such had been the distinction of what was recognized as “a Classical form of implicitly sung poetry.” Now, to get to the root of the problem which we are considering here, we must now look deeper, much deeper. The problem which we need to address, is the absolute distinction of the human mind's essential functions, as contrasted to what is merely human sense-perception. On that account, we should focus attention on the considerable importance of examining the specific agreement to be reached on the definition of a truly universal notion of the exemplary quality of the efficiently ontological existence of the human mind, as that quality was shared on behalf of an explicitly defined matter of agreement reached between the physicist Max Planck and his associate Wolfgang Köhler.

This unique principle respecting mind, which resides in the ontological basis of specifically human creativity, is therefore, now to be located by our human species in the functions of what are conveniently defined as trends toward “Classical artistic composition:” a function which also underlies man's ability to develop true discoveries of universal physical principle. The crucial principle is that to be located in the distinction of the functions of the true human mind, as distinct from the relatively superficial human practice of sense-perception. The crucial conception needed for that principled purpose, is that of metaphor when properly defined.²

There are certain complications to be mentioned here, such as what are called “asides,” such as what are often identified as “ups and downs” in the known history, geographies, and varying cultures among civilizations. The principal types of systemic intellectual and related failures among peoples and their cultures, fall under the title of the effects of oligarchism, as such effects have been typified by the familiar historical cases of the Roman, Byzantine, Venetian, and the “New Venetian” (e.g., British imperialist) systems.

Since the Ouster of Bismarck. The most recent among the principally successive waves of depravities experienced by trans-Atlantic civilization, had been launched by the 1890 dismissal of Germany's Chancellor Otto von Bismarck from his office. The general sweep of cultural degeneration throughout the trans-Atlantic regions, for example, was set into motion immediately following the ouster of Bismarck, as was demonstrated by the British Prince of Wales' alliance with Japan for their war against China, and by

the 1894 assassination of France's President Marie François Sadi Carnot.

The entire sweep of the interval from the 1890 ouster of Bismarck, through to the present moment of threatened global thermonuclear warfare, has been along a persisting general track into what has been an essentially continuing and deepening cultural depravity. The assassination of President William McKinley, like that of Abraham Lincoln earlier, as like the death by exhaustion of President Franklin Roosevelt, and like the successive assassinations of President John F. Kennedy in 1963, and that, on June 6, 1968, of his brother Robert, had been prominent markers of sudden, but also long-ranging periods of declines in the moral and economic-political systems of the United States and certain leading other nations.

The more recent, precipitous, set of national and broader degenerations which has been marked by the cases of such as Presidents George W. Bush, Jr. and Barack Obama, has been expressed in the precipitous fall of the trans-Atlantic, British/Saudi-dominated sector of the planet into its steepest, and still accelerating collapse into a presently “new dark age” decline of the trans-Atlantic region. Unless President Obama were to be suddenly turned out of office, the darkest of all dark ages of mankind were presently diving into an accelerating descent into a planetary “new dark age,” certainly that of the trans-Atlantic regions, but also beyond.

Once we have taken the matters identified in the immediately preceding paragraphs into consideration, we may then, as now, also take the consideration of the conflicting subjects of sense-perception and metaphor into a relatively sharp focus, now, as follows.

The True Principle of Metaphor. To understand these matters competently, it is indispensable that we now recognize the tradition which prompted Johannes Kepler to discover the functional principle of physical science which he had named vicarious hypothesis. It is also indispensable that we recognize the certain quality of equivalence of both Johannes Kepler's notions of vicarious hypothesis and metaphor. The distinction which those usages share, is to be recognized as implicitly emphasizing the incompetence of the attempt to attribute real existence to the experience of mere sense-perception as such. The argument which Shakespeare places on the lips of his Hamlet in the third act's “to be or not to be,” or, as in the open-

ing “chorus” of *Henry V*, are relevant examples reflecting the function of metaphor, rather than the inherent fallacy of a merely quantitative measure.

Stated otherwise, it is sense-perception (more insightfully marked as “sense deception”) which is the shadowy, relatively defective element in the process of human experience. It is the attempt to impose the notions of sense-perception upon populations as “a self-evident reality,” which is the common source of error in any attempt to discover and establish an actually scientific practice. It is the lessening of the dependency on the apparent evidence of sense-perception as such, which implicitly “measures” an improvement in respect to the need to eliminate the quality of inherent error in the generality of the human experience. A closer examination of the general argument encompassing the content of Bernhard Riemann’s habilitation dissertation, actually adopts that outlook which has been the implied point of his approach to the subject of mankind’s practical relationship to the experiencing of the universe through the functions of experimental sense-perception.

It is more than merely useful, to consider those implications from the vantage point of the work of Johann Sebastian Bach, Arthur Nikisch, and Wilhelm Furtwängler in Classical musical composition, as considered in opposition to the systemic silliness of the fallacy of mathematical “sense certainties.” Add to that, the degrees of irrelevance of quantitative measurements with respect to the principles of Classical drama, thus including the role of the effectively efficient, qualitative meanings, meanings which are intrinsic to the specifically ontological content of drama or Classical poetry as such.

This category of considerations takes us from out of the limits inhering in the use of merely deductive methods, into the matter of foreseeing a future yet to be experienced. Highly notable, as within the context of this present report, is my own leading experience in certain scientific matters of forecasting which pertain to the ability to foresee a future development as expressing a specific kind of forecastable effects. This is, of course, my most notable achievement in matters of that general practice, in contrast to the usual failures inherent in statistical and related modes of an attempted economic forecasting of a systemically original development.

The disturbing aspect of such forecasting abilities, is the fact of the inherent trend of

failures inherent in the use of both deductive methods and standards which are, specifically, systemically calculable, retrospectively, but not by deductive, or comparable attempts for discovering the future. All such apparent anomalies share the seemingly nominal characteristics specific to metaphor, and the method of ordering of development within the process of composition represented by Johann Sebastian Bach’s two sets of Preludes and Fugues, as represented by Wilhelm Furtwängler later.

II. The Question of the Future

As I have emphasized immediately above, the essential distinction of that competent insight, which separates such insight from that folly which is inherent in deductive methods, is a matter of a reality to be discovered through the means of a qualified approach to a foreseeing of the future-as-such, as inherently a determinant of the present.³

J.S. Bach’s method, as typified by his work in the two sets of Preludes and Fugues, has the “hearable” implications of a system reflecting the evolutionary emergence of the future. Otherwise, the performance of the work produced by a great composer of music might be considered “pretty,” but not, therefore, as really truthful in the effect of its required performance as a generator of actually physical-scientific progress in the human condition. In proper Classical composition, we require actually creative solutions designed by the intentions of the relevant Classical composers and performers, intentions which must be experienced as such an ordering by the inventor’s specific experience of what is, for him, or for her, as the relevant performance of the future, and that as if instinctively. In brief, it is that perception of the future, or the lack of a real future, which determines the outcome of the present.

That, when stated summarily, is, and remains at the root of my exceptional, registered successes as a forecaster of economic and related processes. My relatively unique career as a successful forecaster, typifies, in the most crucial respects, the essential distinction of the developed potentialities of the human mind, from the failed human methods which conform to the inherent implications of the commonplace, methodologically deductive commitments. The issue which I impose, inherently, in presenting that statement here, is the matter of the urgently needed appreciation of the quality of intention which generates the coming-into-existence of those fundamental prin-

ciples themselves, the principles which must shape the development of society for the actual shaping of any successful quality of a presently intentional course of understanding the future of history, and, therefore, also, what will have become, ironically, the new “past history” of mankind.

When these facts are considered from the standpoint of modern American-European experiences, the available “cultural” evidence is, that the stultification of the higher intellectual abilities of what may be considered the “educated” strata of today, reflects a known characteristic of the existence of “oligarchical society,” rather than that of mankind in our species’ true nature.

Consider the Consequences. The standard “upper class,” often called the “oligarchy,” regards those assigned to the lower class as being merely “practical,” rather than systemically “cognitive.” Ironically, this division of society between “the ruling classes” and “the underlings,” which tends to induce an “upper class” which cultivates its own stupidity as a social class, has the effect of a partition which should remind us of “aristocrat versus serf” – such as the virtual serfs of London’s former Wall Street puppet, President Andrew Jackson.

On this account, in the social history of the population of our United States, since the assassination of President John F. Kennedy, and, thus, since the assassinations of that President and his brother, Robert, there has been an ever more brutish reign of “Wall Street’s oligarchical pretensions,” a moral and intellectual decadence of the privileged “youth,” a decadence which has steered the deepening intellectually-immoral quality of the academic “Sixty-Eighter.”⁴ Since the puppets of British agent Aaron Burr and an ageing Burr’s puppet Andrew Jackson, that Wall Street trend has generated the consequent moral and related, further degenerations among social classes – as in the case of that which has led the trans-Atlantic nationalities into their present. actually decadent impulse for cultural self-extermination, as exhibited by the so-called “environmentalist” degenerates.

Nothing demonstrates the truth of my warning in a better way, than the case of the Boston-New York City-Philadelphia-Chicago-California-et alia university types known as “The Sixty-Eighters.” The typification of that particularly depraved “class” and its effects on the society’s culture-in-general, has been the actually rabid, “stomach-turning” quality of the “greenie sub-culture” whose pathological roots are located in the effects

of the domination of the United Kingdom on post-Charles de Gaulle Europe, by the spawn of France's Mitterrand's monetarist pestilence.

The roots of the degeneration in Europe since the 1763 "Peace of Paris," are located most readily in the immediate aftermath of the influence of Lord Shelburne since that time, and also well past that time, through his 1782 establishment of the British Foreign Office. Shelburne's influence over circles associated, as "seriously confused and other" corruptible ranking strata, from among the leadership of the USA's victory as a sovereign reigning republic, was a crucial factor in the histories of the periods of disorienting the government of the USA, as presently, in the recent periods of Presidential elections, as now.

However, this evidence can not be competently appreciated, until due consideration has been given to the global factors traced directly from "the New Venetian party" of William of Orange and the success of that heritage in Shelburne's imperialist influence and its consequences in what was to become a Shelburne's imperialist influence and its consequences in what was to become a British-empire-in-fact, as in the February 1763 Peace of Paris, through his role of leadership during, and beyond the generality of the 1790s and the Napoleonic wars.

Once the individuals have taken into account such matters as those just referenced above, it should become clear, and also clearer to them, that we must subject ourselves to a sense of the need for a profoundly systemic change in modern conventional notions of the passage of what we denote as "time." The following considerations are now crucial.

"Just in Time." The crucial point to be considered here and now, is lodged within the following fact.

Competent insight into crucial developments occurring in the future, depends upon the developed capability of the forecaster to have predetermined the content of the action by means of which foreknowledge of the "tensions" reflecting the future, changes the present course of events. There are, shall we say "obviously," two considerations to be taken into account. First, the ability to define a change in principle from the present, into the future as acting to change the present. In considering this notion, we find that in the method of composition employed in Johann Sebastian Bach's sets of preludes and fugues, we have an explicit expression of the way, as through the means of the composi-

tion of the fugues, in which the composer's foreknowledge of newly created sensed precursors of pre-determination of the future state, transforms the principles of action.

That typifies the primary approach to understanding a physical principle's effect in its changing the meaning of the conception of an actual future. This is, in the first instance, also the relevant principle of the actually "Classical" composition, which puts the "Romantic" or "Modernist" into systemic opposition to the actually Classical. In the second instance, this refers to the actuality of the process of the discovery of a new universal physical principle. Restated: this means that all discovery of a future principle of the universe, actually changes the universe, as mankind changes man himself.

In principle, this concept had been restated, implicitly, in what has been, essentially, a most forceful way, in Bernhard Riemann's powerfully inspiring 1854 habilitation dissertation. It is also expressed forcefully in the known history of the evolution of living species generally, but most clearly in the upward evolution of the creative power in the evolution of species – and, the power unique to the characteristic existence of our human species' intentional power to change the universe which we inhabit, as no other known species has been enabled to do so. However, we are able to demonstrate that nature of what is specifically uniquely human creativity, as by means associated with the work of Nicholas of Cusa, most emphatically in his *De Docta Ignorantia*. We are empowered, thus, to create what is otherwise defined as an extension of creativity itself.

This is the same power associated with Classical modes of human artistic creativity: we demonstrate the principle of creativity through the action of creating a change in what we believe we know concerning the universe. In other words, Classical artistic composition and evolution of the universe to higher states of existence, are comparable abilities.

III. The Actual Science of Economy

Respecting the fundamentals of the progress of mankind stated this far: we, as a uniquely self-evolving, human species, are confronted essentially with two, successively combined, qualitatively ontological distinctions of our species: (1) a fact which should have carried our attention far beyond the notions of, first, the mere fact of an ontological principle of life as such; and, (2) the uniquely higher quality of existence of the

unique class of phenomena represented by the noëtic potentials specific to what we identify as the human mind. These two distinctions, taken into account, in turn, and, then, combined, must present us with the evidence of the existence of a distinguishable universal principle, which, once duly considered, represents for us, as human beings, a principled phenomenon of self-creativity per se.

What, therefore, is the significance of mankind's development of what had been, previously non-existent capabilities for the present succession of mankind's ability to cultivate a development both on the planet Mars, and respecting the prospect of defeating deadly threats lurking in the space marked out between the range of Mars and Earth? Shift attention from the mere fact of these prospective developments, by rising to the level of the subject of the upward process of ontologically distinct notions of a process of development which, of necessity, had subsumed these developments. Mankind is distinguished as a species, by the option of transforming itself anti-entropically, as no other known species could do.

We do not merely develop those of our powers which are intrinsically noëtic processes; we transform ourselves, ontologically, into evolved beings which have been made potentially capable, in themselves, of what had not been possible for the existence of our species earlier. We, respecting us, are the first known case of an actually self-creative form of living species; we are not merely qualitatively different as a species; we represent a higher order of self-evolution for our species than any other definition of life known to us heretofore: we are, inherently, a willfully creative species which must undergo successive phases of evolution into successively higher qualities of what we may identify as our evolving species. That is our essence, whenever we do not demean the very meaning of our existence, a meaning which is that of expressing the existential meaning of our existence, a meaning which is that of expressing our existential need to impel ourselves to rise, again and again, to a quality above and beyond all other living species known to us at any time.

Were there any reason to suspect that we are less than what I have just described our species to be here, that result were a result of nothing as much as our qualitative self-degradation as members of our species.

What I have, thus, just summarized this far, respecting the uniqueness of human creativity, is to be considered in contrast to

the characteristics of all other known species. This brings our conscience into conflict with previously accepted, erroneous notions of the specific nature of our human species, in absolute contrast to all other known instances.

It is the irony of this specific situation, which distinguishes the principled nature of “Classical artistic composition” from that, inherently, virtually sub-human depravity of what passes for “popular opinion.” In other words, in the terms of fair approximations, the phenomenon which is to be properly regarded as human Classical-artistic creativity, exists consciously only in a willfully higher ordering of existence, ontologically – a virtual, ontological, probably ever-continuing process of virtual species-jumps – a higher order than any other known species of life otherwise defined. We must recognize ourselves as representative of what should always be (or should have been) a self-creating evolution of our apparently unique species, i.e., “specifically human self-creativity.”

We must cease to rely on the popular foolishness of thinking of man as a species which “might” evolve; we are properly destined to be fulfilled in the purpose of our

Nationalism from page 6

Endnotes

1. This may be seen as coming to grips with the social costs that spin off from the operation of the system. See Needham, W. Robert (2006). *Profit as the Root of all Evil: The Devil is in the Details*.
2. See the recent warning in Studin, Irvin (August 26, 2012). Canada is too big to Fail: Canadians tired of the Quebec Question should be careful about what they wish for. *Toronto Star*, p. A13. The shooting outside a Parti Québécois victory rally Tuesday, September 4, 2012, must surely raise some concerns.
3. Taylor, Charles (1966). *Economic Independence for Canada*. Montreal: McGill University Department of Political Science.
4. Taylor, Charles (1982). Nationalism and Independence: An Economic Problem. In Fox, P.W. (Ed.), *Politics Canada* (pp. 169-177). Toronto: McGraw-Hill Ryerson Limited.
5. Lectures included in *Selected Readings to Accompany Canadian Studies 201 – Canadian Community, Existence and Sustainability* at Wilfrid Laurier University, October 26-28, 1993. Transcribed notes of the *Laurier Lectures: The Liberal Communitarian Debate* (October 26, 1993); *Two Theories of Modernity* (October 27, 1993); *The Malaises of Modernity* (October 28, 1993).
6. Nemni, Max (Fall 1999). Canada's Two Nationalisms, Made in Quebec. *Cité Libre*, (pp. 41-47).
7. Kierans Eric & Stewart, Walter (1988). *Wrong End of the Rainbow: The Collapse of Free Enterprise in Canada* (p. 72). Toronto: Collins Publishers.
8. See Camp, Dalton (March 23 2000). *Neo-Conservatism: How to Wreck a County without a Hammer*. Kerr-Saltzman Lecture at the University of Waterloo.
9. See McMurtry, John (1999). *The Cancer Stage of Capitalism*. London and Tokyo: Pluto Press and Springer-Verlag; McMurtry, John (1995). The Social Immune System and the Cancer Stage of Capitalism. *Social Justice: A Journal of Crime, Conflict and World Order, XXII4*, 1-25. McMurtry, John (1984). Fascism and Neo-Conservatism Is there a Difference. *Praxis International, IV*, 86-102.

existence as a virtual succession of evolutionary transformations, by means of which to rise to relatively higher qualitative states of existence across successive generations: once we were intentionally and eternally oriented to an upward-evolving succession of generations, a series of qualitative ordering of the upward self-evolution of the human mind. The human species' innate intention in existing, is distinguished by its uniquely destined reliance on the discovery of what are, in effect, intentional successions of successively higher noetic states of existence: ever higher energy-flux density of the species' existence. The failure of mankind to evolve to that progressive effect, expresses a willful, or quasi-willful failure in our species' behavior.

Consider the pending development of our species, thus, against the already existing evidence of mankind's relatively immediate destiny as mankind's necessary mastery of Mars and other places from which we must now muster the defense of Earth against menacing natural satellites and comets. Let us, therefore, now re-examine what I have written here this far, proceeding from the just-stated, higher order of conceptions.

Beyond a Thermonuclear Defense of Earth. The present standpoint for defining the role of mankind within, and beyond the Solar System, has been expressed by the role of Dr. Edward Teller in respect to both the Strategic Defense Initiative (SDI) and the related subject-matter of defense of life on Earth from collisions with all potentially dangerous debris, such as satellites, “floating” within “space.”

Apart from a limited potential for human visits to Mars, mankind's prospective near-term visits are not the leading priority for human activity on that planet. What has been demonstrated, in principle, for man on Mars, so far, is the more immediate potential for the use of higher orders of successor instruments to “Curiosity,” such as instruments for the kind of defense of Earth against “natural satellites” adopted as a long-ranging mission-assignment by the late Dr. Edward Teller. This means the extension of the successful design of a mission orientation for military strategic defense on Earth, to a higher mission of systemic defense against the vast panoply of both “natural satellites” and the far more menacing comets among known objects within Solar space at large.

The immediately interesting considerations feature a certain prospective benefit for mankind which has been brought into

consideration by the success of “Curiosity.” The establishment of the placing of operating systems on Mars now, brings our perspective closer to the prospect of placing operating systems more advanced than “Curiosity” typifies, into the means for setting into place on Mars, controllable operating systems, which have an obvious mission assignment for assisting the defense of mankind on Earth in ways not otherwise feasible. The fact that systems on Earth and Mars, respectively, are “in communication” at the speed of light, should be coming to be recognized as useful to mankind on Earth in many, largely obvious ways, including “reciprocal assistance” in “diagnosing and directing” operations needed for discovery of, and actions against threats from roaming satellites threatening Earth. This is of particular importance for defense against comets.

Endnotes

1. For example, Shakespeare's character Hamlet wrote: “...Thus conscience does make cowards of us all; and thus the native hue of resolution is sicklied o'er with the pale cast of thought; and enterprises of great pith and merit, with this regard, their currents turn awry, and lose the name of action....”

2. The currently, widely and wildly mis-defined meaning assigned to the name of metaphor, is chiefly a product of a cultural degeneration which became embedded with the replacement of “Classical” by the decadence of trans-Atlantic “Romantic” and “Modernist” culture. See later comment on this here.

3. This is the potentially essential distinction of man, systemically, from higher orders of species of beasts. A person may be more or less capable of reacting to the products of actually creative mention, but tends to be usually “blocked” against forming independent insights of this specific quality as of a species of “what is yet to become.” Hence, the implicitly sub-human depravity of the British imperialist system, like all preceding empires as such.

4. During the midday hours following the assassination of Robert Kennedy, I intervened to prevent Mark Rudd and his followers from mobilizing their intended plan to celebrate the assassination of that Presidential candidate. A leading member of that group of my adversaries acceded to my warning that such an action by Rudd's crew would have aroused the contempt of the population generally.

Disaster, Data Loss and the Cloud

By Joe Mullich, *The Wall Street Journal*,
September 24, 2012

Many companies consider their data to be their most valuable asset. However, they've been challenged trying to keep their "crown jewels" safe, especially from the increasing number of natural disasters around the globe as well as a host of man-made snafus.

A recent study of 300 companies across North America found that every single one had suffered a data or application loss in the previous year. A growing mound of other research confirms the problem is costly and widespread.

The reasons vary and overlap – software failure, a hacker attack, an employee error – but the issue crosses all industries and all sizes of companies. "This is not an esoteric conversation about a rare occurrence," says Dick Csaplar, a senior research analyst at the Aberdeen Group. "This is a problem almost every company is facing every day; this is a sword hanging over their heads."

As the amount, and consequences, of data loss rise, companies are finding a new way to better protect their data – through the cloud. More than half of the companies in the survey expect their use of cloud computing in their business continuity strategy to increase in the coming year.

"This growing acceptance of using the cloud to safely store data will continue to increase as costs come down and ease of accessibility increases," says Sun Jiawei, marketing director of IT product line for Huawei Enterprise Business Group.

Storage and backup solutions are already the most popular cloud applications, according to a recent study by CompTIA, a global computer industry association. This is especially true among small and mid-size businesses (SMBs), where 71 percent of these organizations are currently using cloud storage and backup. Along with the expansion of the public cloud, many larger organizations have started to deploy their own private clouds for application, computing and content (archival) storage.

The cloud provides many benefits over traditional methods of storing and backing up data. For example, many smaller companies now back up their data with antiquated methods, such as putting them on USB flash drives or CDs/DVDs.

These manual methods of backup have numerous drawbacks. For one thing, the

process gobbles up lots of the IT department's time. Not infrequently the backups are overlooked or not tested, so no one knows if the information will be available if there are problems.

Even when backup is done correctly and on schedule, the disks or tapes may be taken to an offsite facility in the same city, meaning the data is at risk if a flood or other disaster strikes the community. If the tapes are kept far away from the primary site, it can be difficult to restore the information quickly – what IT departments refer to as recovery-time objectives (RTO).

And keep in mind these are the problems of companies that actually back up their data. A surprisingly large number of organizations ignore this basic step in safeguarding information. A recent survey found that 31 percent of small businesses around the globe don't back up email, 21 percent don't back up application data and 17 percent don't back up customer data – including many companies that were based in areas prone to natural disasters and believed they would lose at least 40 percent of their data if a disaster struck.

"A lot of companies are suboptimal when it comes to their disaster recovery planning," says Larry Ponemon, chairman and founder of the Ponemon Institute. "They think it's all right if they can recover 65 percent of their data, as long as it's the right 65 percent. But that puts a lot of their information at risk. The cloud is the best environment for system-wide backup."

The cloud eliminates many of these issues, by making the backup process automatic and making the restoration of the information easier. Two years ago, the Aberdeen Group polled 100 companies that had formal disaster recovery (DR) programs and used public cloud storage. Those companies said they recovered information four times faster than companies with formal DR programs that didn't use cloud storage.

Csaplar says the eight-hour recovery time for noncloud users suggests a heavy reliance on emergency tape backup, since eight hours is about how long it takes to recall an archive tape and recover the missing data from the tape. Considering that the average cost of downtime is \$138,000 an hour, that's a costly delay. For large companies, an hour of downtime can cost \$1.1 million.

The cloud provides numerous mecha-

nisms for safeguarding data. Traditionally, a program runs on a dedicated physical machine, and any system outage or physical issue would impact the program directly and result in data loss. With the cloud, the program runs on a virtual machine. The physical layer is separated from the software layer. This pools all the physical resources, allocating them when they are needed, and eliminates the single point of failure in the traditional approach.

"Meanwhile, the cloud operating system supports data storage by distribution mode or mirror mode, meaning that the data will be duplicated and stored in different physical disks in the pool," Jiawei says. "This guarantees data safety and allows for easy data recovery."

On top of this, organizations that use the cloud can opt to implement a multi-pronged approach to data protection. It can provide automatic data encryption, auditing of operation logs, more stringent ways to authenticate users and other security mechanisms.

"A lot of folks are still leery about the safety and security of the cloud," Ponemon says. "They fear that if the data is physically somewhere else, they'll lose a degree of freedom and not be able to recover properly. What's ironic," he adds, "is that the security posture of many cloud providers is better than the security that many companies currently have in-house."



Our Comment. It is ironic that those who supposedly assure the safety of society's most valuable reserves should entrust blindly to those who greedily mistake human capital for an expense rather than society's most crucial asset. Could the cloud not be redesigned to remind the world that human capital is the most valuable of our key reserves? And that those who greedily mistake it for an asset leave our world flying blind to global disaster. *W.K.*

Check out the
COMER bookstore
at www.comer.org

The Campaign for Peace and Democracy

Dear friends,

We are writing you at this crucial moment to invite you to sign the Campaign for Peace and Democracy statement entitled “We Stand with the Greek People Fighting Austerity – For Their Sake and Ours.”

We very much hope that you will join the initial 151 signers of the statement. A large number of signatures can make a real difference and will help let people in Greece know that they are not alone as they resist the cruel austerity measures the “Troika” (the European Central Bank, The European Commission, and the International Monetary Fund) are attempting to impose on the Greek population – with the acquiescence of the current Greek government.

If you wish to add your name to the CPD solidarity statement, see the emerging list of signers and their affiliations, and for make a tax-deductible donation to publicize the statement, please go to our website. We are especially concerned to publicize the statement soon, because each day brings news of further savage austerity measures and we need to show our solidarity now with those fighting back.

A list of the initial signers and the text of the statement are below. We hope to collect a large number of signatures very quickly, and then publish the statement as widely as possible, in this country, in Greece, and internationally – beginning with ads in *The Nation* and *The Progressive* magazine. You do not have to donate in order to sign.

(Signers’ names are available on the CPD website.)

If you’ve already signed the statement but not yet contributed to our publicity efforts, you can go directly to the donation page on our website. The world must be made aware that many people around the globe are appalled by the devastating sacrifices being demanded of the Greek people and that we support their resistance.

In peace and solidarity,

Joanne Landy, Thomas Harrison, Co-Directors, Campaign for Peace and Democracy
We Stand with the Greek People Fighting Austerity – For Their Sake and Ours
September 2012

Statement of the Campaign for Peace and Democracy

www.cpdweb.org/stmnts/1022/stmt.shtml

What is happening today in Greece is only the most extreme example of a global

phenomenon: the world’s political and economic elites, who are responsible for the current economic crisis, want to make the rest of us pay for that crisis, no matter how much suffering this creates. But Greece also exemplifies the determined resistance of millions of ordinary people who refuse to pay for a crisis they did not cause. Their fight is a model for all of us.

Greeks are subjected to an extraordinarily harsh austerity program that has devastated the lives of most of the population. Draconian measures demanded by European bankers and politicians and carried out by the Greek government have drastically reduced workers’ wages, pensions, social welfare and labor rights; poverty and hunger are rising rapidly, and suicides of people unable to cope with their rapidly deteriorating circumstances are increasingly common. Hospitals lack basic medical supplies, and the under-funding of government social insurance is making it impossible for many Greeks to obtain the medicines they desperately need to survive. Current unemployment for the general population is officially 23 percent, but in reality closer to 30 percent, and over 50 percent for young people.

Meanwhile, the Greek government continues to bail out Greek banks and to sell off precious public assets at scandalously low prices. For global elites, Greece is a laboratory for a savage form of neo-liberalism – the wholesale privatization of public goods, deregulation of markets and turning the workforce into a powerless and financially precarious underclass wholly dependent on employers.

But Greeks have forthrightly declined to play the role of guinea pigs. We are deeply heartened and inspired by the Greek people’s resistance. They have mounted general strikes, massive demonstrations and occupations, and, most recently, they have voted in large and increasing numbers for a left-wing political party, SYRIZA, which is leading strong opposition to the government’s catastrophic policies and has a good chance of winning the next election.

Greece is worse off than most developed countries, but it is not unique. The worldwide crisis, which is actually worsened by austerity policies, is being used as an opportunity to take away hard won social and labor rights everywhere. Though most other countries haven’t yet seen policies as

punitive as those in Greece, throughout the OECD unemployment remains high, while cutbacks lead to massive layoffs, and deficits are used as an excuse to attack public services. In the United States the banks have foreclosed millions of homes, students are burdened with huge debts they are unable to repay, and a vicious assault has been waged on the collective bargaining rights of public sector workers.

Austerity policies also pose a critical threat to democracy. Increasingly, elites are seeking to insulate economic decision-making from democratic control. To them, not just Greeks but ordinary people everywhere cannot be trusted to act “responsibly” and therefore do not “deserve” democracy. For the elites, austerity is imperative not only to “solve” the crisis, but also to restore unfettered markets – that is, the very conditions that threw the world into an economic and social meltdown in the first place. The people, who fail to grasp the wisdom of neo-liberal ideology, cannot be allowed to interfere.

At the same time, however, grassroots democratic resistance to austerity is intensifying. As in Greece there have been large-scale strikes, demonstrations and occupations of public space in Egypt, Spain, Chile, South Africa, Mexico, China, Quebec, Wisconsin, and the Occupy movement around the world.

In Greece, the left is also struggling to prevent the neo-Nazi Golden Dawn from turning people’s rage and desperation against immigrants. Golden Dawn’s violent pogroms are paralleled by the Greek government’s persecution of immigrants, both documented and undocumented. The crisis has likewise fostered the growth of the extreme right in Europe and the US, as well as xenophobic demagoguery and repression by “mainstream” politicians. It is all the more urgent, therefore, to support the Greek left and to promote elsewhere its radical democratic proposals: taxing wealth, nationalizing banks, cutting military spending, boosting wages and social services, and strengthening labor rights.

We Are All Greeks!

Greece is the site of a cruel experiment by economic and political elites: driving people into extreme poverty and stripping them of their social rights as a “solution” to the economic crisis. It is an experiment that

these elites wish to extend throughout the world. They have already begun. We declare that it doesn't have to be this way. We stand with the Greek resistance to austerity, both as a moral imperative and because it shows the way to secure a decent future for people everywhere.

Co-Directors: Joanne Landy and
Thomas Harrison
Campaign for Peace and Democracy
2790 Broadway, #12
New York, NY 10025
cpd@igc.org, www.cpdweb.org

Our Comment

SYRIZA is well informed of COMER's position and we are shocked to see that your appeal does not include humanity's debt to classical Greece. Socrates wrote nothing but asked important questions. For that he was put to death. But he left a great inheritance to Plato and other scholars who led from Socrates' questions to an understanding that you cannot simply turn around a question to find a proper answer. Such answers can only come by noting the effects in all possible directions, and even on the phase

of the moon. This is the lesson of ancient Greece that must be retrieved. Its suppression means that not a single government today on this globe meets the key criteria of Plato and other disciples of classical Greece, and has nothing that could be mistaken for serious accountancy – our denied heritage from Ancient Greece. COMER is prepared to make a contribution to your cause – provided that it covers our key heritage from Ancient Greece. Without it, you all are striking out.

William Krehm, for COMER

"A New type of Distinct Society" or "A New Kind of Politics?"

By Richard Priestman, President, Kingston Chapter, Committee on Monetary and Economic Reform

"Will Quebec remain egalitarian or will austerity lead to a socially fractured and economically divided society as it has in the rest of Canada?"

"The protests decry what Charest's Finance Minister Raymond Bachand refers to as the coming "user pay culture," in which basic rights, such as accessible post-secondary education and inexpensive daycare, are now referred to in an Orwellian twist as "entitlements" to be paid for by the end user."

Cuts to education and inexpensive day care (and other public services, public infrastructure and environmental protection) are unnecessary because there would be sufficient money if billions of dollars were not spent on unnecessary public debt interest arising from government borrowing from the private market, including commercial banks, instead of from Canada's central bank, the Bank of Canada, at effectively zero interest. This (zero interest) occurs because the federal government owns the Bank, and all interest paid into it is returned to the government minus a little for administrative costs.

Unnecessary interest paid on public debt by federal government – \$31 billion (2011)

Unnecessary interest paid on public debt by our three levels of government – \$60 billion (\$165 million a day)¹

Unnecessary interest paid on Quebec's public debt – \$9.855 billion (2011-2012)²

In 2011-2012 the people of Quebec paid \$27 million a day on public debt interest.

Question: How much could colleges and universities lower student fees with a cash infusion of \$27 million (which is the amount Quebec spends on public debt in-

terest in one day)?

The "Occupy Kingston" group and similar groups across the country have said to the community, "Wake up! Our government is run by banks and large corporations! The '1%' have more wealth than the rest of us; we have an unjust society, and the gap between the wealth of the '1%' and the rest is growing." One of the things that is contributing to that gap is the unnecessary and mostly undeserved interest we pay on public debt to our 3 levels of government of \$165 million a day, \$5 a day for every man, woman and child in the country – \$60 billion a year! Our governments dig deep into our pockets every day through taxes of all kinds, take our money and send it to the banks and wealthy bond holders to pay the interest. This helps to make the gap wider.

The federal government could reduce the interest paid on public debt by borrowing more from the Bank of Canada at near zero cost and less from private financiers. So, why doesn't it do that? The government is up to its neck in interest-bearing debt of over \$800 billion – and when you owe that much you are inclined to listen to the wants of your creditors over the needs of ordinary Canadians. Government indebtedness to private financiers gives that sector undue influence over government policy decisions. It is not in the interest of banks and wealthy bond holders for the government to borrow from the Bank of Canada, but it is in the interest of ordinary Canadians. Not only would it save billions in debt charges, but more importantly it would reduce the influence of private sector financiers on government policy decisions. This would occur because use of the Bank in this way provides government an alternative source of financing for its debt – and therefore

more independence to adopt policies which are in the interest of most Canadians even if not to the liking of its major bond holders and the banks.

Provinces could borrow from the Bank of Canada, too, but this would require the federal government's co-operation and willingness to rebate the interest paid. An alternative is that the federal government would borrow funds from the Bank of Canada for the use of the provinces.

Can we change the situation? Yes, but only if we reduce the influence of banks and wealthy bond holders on our government by electing supportive politicians.

To save public education (and other public services, public infrastructure and the environment) we must say to our politicians and political candidates, "If you want my vote you have to agree to support use of the Bank of Canada for financing public debt to invest in public services, public infrastructure and protection of the environment." Note: this use does not include financing for aggression or aggressive weaponry.

If, in a given riding, none of the party affiliated candidates agrees to this, the community could then organize to elect an independent candidate. We have a choice!

It could be thought of as a new kind of politics!

Endnotes

1. Statistics Canada, *Canadian Economic Observer: Historical Statistical Supplement*. www.statcan.gc.ca/pub/11-210-x/2010000/t008-eng.htm. Table 1.3-1. You will see there that interest on the public debt for total government in 2010 amounted to \$60.2 billion or \$165 million per day.

| Service de la dette consolidé | |
|-------------------------------|---------|
| 2010-2011 | 8935 M |
| 2011-2012 | 9855 M |
| 2012-2013 | 10854 M |

2. *Dépenses Fiscales*, édition 2011, Québec p. 70. Illustration de l'impact de la comptabilisation des dépenses liées au régime fiscal sur le cadre financier consolidé.

Silent Weapons for Quiet Wars

The following article was provided to COMER in a PDF and is printed as received.

The following document is taken from two sources. The first, was acquired on a website (of which I can't remember the address) listing as its source the book titled *Behold A Pale Horse* by William Cooper; Light Technology Publishing, 1991. The second source is a crudely copied booklet which does not contain a copyright notice, or a publishers name. With the exception of the Forward, the Preface, the main thing that was missing from the first source was the illustrations. As we began comparing the two, we realized that the illustrations, and the accompanying text (also missing from the first) made

up a significant part of the document. This has now been restored by The Lawful Path (www.lawfulpath.com), and so far as I know, is the only internet copy available complete with the illustrations.

We have no first-hand knowledge that this document is genuine, however many of the concepts contained herein are certainly reasonable, important, and bear strong consideration.

If anyone has additional knowledge about the source of this document, has better copies of the illustrations than the ones posted here, has any missing pieces to this document, or has any comments which can improve upon the quality of this document, we will appreciate your comments.

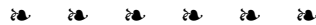

The Lawful Path Forward

This manuscript was delivered to our offices by an unknown person. We did not steal the document, nor are we involved with any theft from the United States Government, and we did not get the document by way of any dishonest methods. We feel that we are not endangering the "National Security" by reproducing this document, quite the contrary; it has been authenticated and we feel that we are not only within our rights to publish it, but morally bound to do so.

Regarding the training manual, you may have detected that we had to block out the marginal notes made by the selectee at the CIA Training Center, but I can assure you that the manual is authentic, and was printed for the purpose of introducing the selectee to the conspiracy. It has been authenticated by four different technical writers for Military Intelligence, one just recently retired who wants very much to have this manual distributed throughout the world, and one who is still employed as an Electronics Engineer by the Federal Government, and has access to the entire series of Training Manuals. One was stationed in Hawaii, and held the highest security clearance in the Naval Intelligence, and another who is now teaching at a university, and has been working with the Central Intelligence Agency for a number of years, and wants out before the axe falls on the conspirators.

We believed that the entire world should know about this plan, so we distributed internationally one-hundred of these manuscripts, to ask individuals at top level positions their opinions. The consensus opinion was to distribute this to as many people as who wanted it, to the end that they would not only understand that "War" had been

declared against them, but would be able to properly identify the true enemy to Humanity.

Delamer Duverus

Preface

Conspiracy theories are nothing new to history. Plots to "kill Caesar" and overthrow Rome abounded, for instance. However, it is seldom that concrete clues to such plots come to light, and are generally known.

Silent Weapons for Quiet Wars, An Introduction Programming Manual was uncovered quite by accident on July 7, 1986 when an employee of Boeing Aircraft Co. purchased a surplus IBM copier for scrap parts at a sale, and discovered inside details of a plan, hatched in the embryonic days of the "Cold War" which called for control of the masses through manipulation of industry, peoples' pastimes, education and political leanings. It called for a quiet revolution, putting brother against brother, and diverting the public's attention from what is really going on.

The document you are about to read is real. It is reprinted in its virgin form, with diagrams, as a touch of reality. It is dated May 1979 and was found on July 7, 1986, in an IBM copier that had been purchased at a surplus sale.

Silent Weapons for Quiet Wars, Operations Research Technical Manual, TM-SW7905.1

TOP SECRET

Welcome Aboard. This publication marks the 25th anniversary of the Third World War, called the "Quiet War," being conducted using subjective biological warfare, fought with "silent weapons."

This book contains an introductory description of this war, its strategies, and its weaponry.

May 1979 #74-1120

Security. It is patently impossible to discuss social engineering or the automation of a society, i.e., the engineering of social automation systems (silent weapons) on a national or worldwide scale without implying extensive objectives of social control and destruction of human life, i.e., slavery and genocide.

This manual is in itself an analog declaration of intent. Such a writing must be secured from public scrutiny. Otherwise, it might be recognized as a technically formal declaration of domestic war. Furthermore, whenever any person or group of persons in a position of great power and without full knowledge and consent of the public, uses such knowledge and methodologies for economic conquest – it must be understood that a state of domestic warfare exists between said person or group of persons and the public.

The solution of today's problems requires an approach which is ruthlessly candid, with no agonizing over religious, moral or cultural values.

You have qualified for this project because of your ability to look at human society with cold objectivity, and yet analyze and discuss your observations and conclusions with others of similar intellectual capacity without the loss of discretion or humility. Such virtues are exercised in your own best interest. Do not deviate from them.

Historical Introduction. Silent weapon technology has evolved from *Operations Research* (OR), a strategic and tactical methodology developed under the Military Management in England during World War II. The original purpose of Operations Research was to study the strategic and tactical problems of air and land defense with the objective of effective use of limited military resources against foreign enemies

(i.e., logistics).

It was soon recognized by those in positions of power that the same methods might be useful for totally controlling a society. But better tools were necessary.

Social engineering (the analysis and automation of a society) requires the correlation of great amounts of constantly changing economic information (data), so a high-speed computerized data-processing system was necessary which could race ahead of the society and predict when society would arrive for capitulation.

Relay computers were too slow, but the electronic computer, invented in 1946 by J. Presper Eckert and John W. Mauchly, filled the bill.

The next breakthrough was the development of the *simplex method* of linear programming in 1947 by the mathematician George B. Dantzig.

Then in 1948, the transistor, invented by J. Bardeen, W.H. Brattain, and W. Shockley, promised great expansion of the computer field by reducing space and power requirements.

With these three inventions under their direction, those in positions of power strongly suspected that it was possible for them to control the whole world with the push of a button.

Immediately, the Rockefeller Foundation got in on the ground floor by making a four-year grant to Harvard College, funding the Harvard Economic Research Project for the study of the structure of the American Economy. One year later, in 1949, the United States Air Force joined in.

In 1952 the grant period terminated, and a high-level meeting of the Elite was held to determine the next phase of social operations research. The Harvard project had been very fruitful, as is borne out by the publication of some of its results in 1953 suggesting the feasibility of economic (social) engineering. (*Studies in the Structure of the American Economy* – copyright 1953 by Wassily Leontief, International Science Press Inc., White Plains, New York).

Engineered in the last half of the decade of the 1940s, the new Quiet War machine stood, so to speak, in sparkling gold-plated hardware on the showroom floor by 1954.

With the creation of the *maser* in 1954, the promise of unlocking unlimited sources of fusion atomic energy from the heavy hydrogen in sea water and the consequent availability of unlimited social power was a possibility only decades away.

The combination was irresistible.

The Quiet War was quietly declared by the International Elite at a meeting held in 1954. Although the silent weapons system was nearly exposed 13 years later, the evolution of the new weapon-system has never suffered any major setbacks.

This volume marks the 25th anniversary of the beginning of the Quiet War. Already this domestic war has had many victories on many fronts throughout the world.

Political Introduction. In 1954 it was well recognized by those in positions of authority that it was only a matter of time, only a few decades, before the general public would be able to grasp and upset the cradle of power, for the very elements of the new silent-weapon technology were as accessible for a public utopia as they were for providing a private utopia.

The issue of primary concern, that of dominance, revolved around the subject of the energy sciences.

Energy. Energy is recognized as the key to all activity on earth. Natural science is the study of the sources and control of natural energy, and social science, theoretically expressed as economics, is the study of the sources and control of social energy. Both are bookkeeping systems: mathematics. Therefore, mathematics is the primary energy science. And the bookkeeper can be king if the public can be kept ignorant of the methodology of the bookkeeping.

All science is merely a means to an end. The means is knowledge. The end is control. Beyond this remains only one issue: Who will be the beneficiary?

Consequently, in the interest of future world order, peace, and tranquility, it was decided to privately wage a quiet war against the American public with an ultimate objective of permanently shifting the natural and social energy (wealth) of the undisciplined and irresponsible many into the hands of the self-disciplined, responsible, and worthy few.

In order to implement this objective, it was necessary to create, secure, and apply new weapons which, as it turned out, were a class of weapons so subtle and sophisticated in their principle of operation and public appearance as to earn for themselves the name “silent weapons.”

In conclusion, the objective of economic research, as conducted by the magnates of capital (banking) and the industries of commodities (goods) and services, is the establishment of an economy which is totally predictable and manipulatable.

In order to achieve a totally predictable economy, the low-class elements of society

must be brought under total control, i.e., must be housebroken, trained, and assigned a yoke and long-term social duties from a very early age, before they have an opportunity to question the propriety of the matter. In order to achieve such conformity, the lower-class family unit must be disintegrated by a process of increasing preoccupation of the parents and the establishment of government-operated day-care centers for the occupationally orphaned children.

The quality of education given to the lower class must be of the poorest sort, so that the moat of ignorance isolating the inferior class from the superior class is and remains incomprehensible to the inferior class. With such an initial handicap, even bright lower class individuals have little if any hope of extricating themselves from their assigned lot in life. This form of slavery is essential to maintain some measure of social order, peace, and tranquility for the ruling upper class.

Descriptive Introduction of the Silent Weapon. Everything that is expected from an ordinary weapon is expected from a silent weapon by its creators, but only in its own manner of functioning.

It shoots situations, instead of bullets; propelled by data processing, instead of chemical reaction (explosion); originating from bits of data, instead of grains of gunpowder; from a computer, instead of a gun; operated by a computer programmer, instead of a marksman; under the orders of a banking magnate, instead of a military general.

It makes no obvious explosive noises, causes no obvious physical or mental injuries, and does not obviously interfere with anyone's daily social life.

Yet it makes an unmistakable “noise,” causes unmistakable physical and mental damage, and unmistakably interferes with the daily social life, i.e., unmistakable to a trained observer, one who knows what to look for.

The public cannot comprehend this weapon, and therefore cannot believe that they are being attacked and subdued by a weapon.

The public might instinctively feel that something is wrong, but that is because of the technical nature of the silent weapon, they cannot express their feeling in a rational way, or handle the problem with intelligence. Therefore, they do not know how to cry for help, and do not know how to associate with others to defend themselves against it.

When a silent weapon is applied gradually, the public adjusts/adapts to its presence

and learns to tolerate its encroachment on their lives until the pressure (psychological via economic) becomes too great and they crack up.

Therefore, the silent weapon is a type of biological warfare. It attacks the vitality, options, and mobility of the individuals of a society by knowing, understanding, manipulating, and attacking their sources of natural and social energy, and their physical, mental, and emotional strengths and weaknesses.

Theoretical Introduction. “Give me control over a nation’s currency, and I care not who makes its laws.” – Mayer Amschel Rothschild, 1743-1812.

Today’s silent weapons technology is an outgrowth of a simple idea discovered, succinctly expressed, and effectively applied by the quoted Mr. Mayer Amschel Rothschild. Mr. Rothschild discovered the missing passive component of economic theory known as economic inductance. He, of course, did not think of his discovery in these 20th-century terms, and, to be sure, mathematical analysis had to wait for the Second Industrial Revolution, the rise of the theory of mechanics and electronics, and finally, the invention of the electronic computer before it could be effectively applied in the control of the world economy.

General Energy Concepts. In the study of energy systems, there always appears three elementary concepts. These are potential energy, kinetic energy, and energy dissipation. And corresponding to these concepts, there are three idealized, essentially pure physical counterparts called passive components.

1. In the science of physical mechanics, the phenomenon of *potential energy* is associated with a physical property called elasticity or stiffness, and can be represented by a stretched spring.

In electronic science, potential energy is stored in a capacitor instead of a spring. This property is called capacitance instead of elasticity or stiffness.

2. In the science of physical mechanics, the phenomenon of *kinetic energy* is associated with a physical property called inertia or mass, and can be represented by a mass or a flywheel in motion.

In electronic science, kinetic energy is stored in an inductor (in a magnetic field) instead of a mass. This property is called inductance instead of inertia.

3. In the science of physical mechanics, the phenomenon of *energy dissipation* is associated with a physical property called friction or resistance, and can be represented

by a dashpot or other device which converts energy into heat.

In electronic science, dissipation of energy is performed by an element called either a resistor or a conductor, the term “resistor” being the one generally used to describe a more ideal device (e.g., wire) employed to convey electronic energy efficiently from one location to another. The property of a resistance or conductor is measured as either resistance or conductance reciprocals.

In economics these three energy concepts are associated with:

1. Economic Capacitance – Capital (money, stock/inventory, investments in buildings and durables, etc.)

2. Economic Conductance – Goods (production flow coefficients)

3. Economic Inductance – Services (the influence of the population of industry on output)

All of the mathematical theory developed in the study of one energy system (e.g., mechanics, electronics, etc.) can be immediately applied in the study of any other energy system (e.g., economics).

Mr. Rothchild’s Energy Discovery. What Mr. Rothschild had discovered was the basic principle of power, influence, and control over people as applied to economics. That principle is “when you assume the appearance of power, people soon give it to you.”

Mr. Rothschild had discovered that currency or deposit loan accounts had the required appearance of power that could be used to induce people (inductance, with people corresponding to a magnetic field) into surrendering their real wealth in exchange for a promise of greater wealth (instead of real compensation). They would put up real collateral in exchange for a loan of promissory notes. Mr. Rothschild found that he could issue more notes than he had backing for, so long as he had someone’s stock of gold as a persuader to show his customers.

Mr. Rothschild loaned his promissory notes to individual and to governments. These would create overconfidence. Then he would make money scarce, tighten control of the system, and collect the collateral through the obligation of contracts. The cycle was then repeated. These pressures could be used to ignite a war. Then he would control the availability of currency to determine who would win the war. That government which agreed to give him control of its economic system got his support.

Collection of debts was guaranteed by economic aid to the enemy of the debtor.

The profit derived from this economic methodology made Mr. Rothschild all the more able to expand his wealth. He found that the public greed would allow currency to be printed by government order beyond the limits (inflation) of backing in precious metal or the production of goods and services.

Apparent Capital as “Paper” Inductor. In this structure, credit, presented as a pure element called “currency,” has the appearance of capital, but is in effect negative capital. Hence, it has the appearance of service, but is in fact, indebtedness or debt. It is therefore an economic inductance instead of an economic capacitance, and if balanced in no other way, will be balanced by the negation of population (war, genocide). The total goods and services represent real capital called the gross national product, and currency may be printed up to this level and still represent economic capacitance; but currency printed beyond this level is subtractive, represents the introduction of economic inductance, and constitutes notes of indebtedness.

War is therefore the balancing of the system by killing the true creditors (the public which we have taught to exchange true value for inflated currency) and falling back on whatever is left of the resources of nature and regeneration of those resources.

Mr. Rothschild had discovered that currency gave him the power to rearrange the economic structure to his own advantage, to shift economic inductance to those economic positions which would encourage the greatest economic instability and oscillation.

The final key to economic control had to wait until there was sufficient data and high-speed computing equipment to keep close watch on the economic oscillations created by price shocking and excess paper energy credits – paper inductance/inflation.

Breakthrough. The aviation field provided the greatest evolution in economic engineering by way of the mathematical theory of shock testing. In this process, a projectile is fired from an airframe on the ground and the impulse of the recoil is monitored by vibration transducers connected to the airframe and wired to chart recorders.

By studying the echoes or reflections of the recoil impulse in the airframe, it is possible to discover critical vibrations in the structure of the airframe which either vibrations of the engine or *aeolian vibrations* of the wings, or a combination of the two, might reinforce resulting in a resonant self-destruction of the airframe in flight as an aircraft. From the standpoint of engi-

neering, this means that the strengths and weaknesses of the structure of the airframe in terms of vibrational energy can be discovered and manipulated.

Application in Economics. To use this method of airframe shock testing in economic engineering, the prices of commodities are shocked, and the public consumer reaction is monitored. The resulting echoes of the economic shock are interpreted theoretically by computers and the psycho-economic structure of the economy is thus discovered. It is by this process that *partial differential and difference matrices* are discovered that define the family household and make possible its evaluation as an economic industry (dissipative consumer structure).

Then the response of the household to future shocks can be predicted and manipulated, and society becomes a well-regulated animal with its reins under the control of a sophisticated computer-regulated social energy bookkeeping system.

Eventually every individual element of the structure comes under computer control through a knowledge of personal preferences, such knowledge guaranteed by computer association of consumer preferences (universal product code, UPC; zebra-striped pricing codes on packages) with consumers (identified via association with the use of a credit card and later a permanent "tattooed" body number invisible under normal ambient illumination).

Summary. Economics is only a social extension of a natural energy system. It, also, has its three passive components. Because of the distribution of wealth and the lack of communication and data, this field has been the last energy field for which a knowledge of these three passive components has been developed.

Since energy is the key to all activity on the face of the earth, it follows that in order to attain a monopoly of energy, raw materials, goods, and services and to establish a world system of slave labor, it is necessary to have a first strike capability in the field of economics. To maintain our position, it is necessary that we have absolute first knowledge of the science of control over all economic factors and the first experience at engineering the world economy.

To achieve such sovereignty, we must at least achieve this one end: that the public will not make either the logical or mathematical connection between economics and the other energy sciences or learn to apply such knowledge.

This is becoming increasingly difficult to

control because more and more businesses are making demands upon their computer programmers to create and apply mathematical models for the management of those businesses.

It is only a matter of time before the new breed of private programmer/economists will catch on to the far reaching implications of the work begun at Harvard in 1948. The speed with which they can communicate their warning to the public will largely depend upon how effective we have been at controlling the media, subverting education, and keeping the public distracted with matters of no real importance.

The Economic Model. Economics, as a social energy science has as a first objective the description of the complex way in which any given unit of resources is used to satisfy some economic want (Leontief Matrix). This first objective, when extended to get the most product from the least or limited resources, comprises that objective of general military and industrial logistics known as Operations Research. (See simplex method of linear programming.)

The Harvard Economic Research Project (1948-) was an extension of World War II Operations Research. Its purpose was to discover the science of controlling at first the American economy, and then the world economy. It was felt that with sufficient mathematical foundation and data, it would be nearly as easy to predict and control the trend of an economy as to predict and control the trajectory of a projectile. Such has proven to be the case. Moreover, the economy has been transformed into a guided missile on target.

The immediate aim of the Harvard project was to discover the economic structure, what forces change that structure, how the behavior of the structure can be predicted, and how it can be manipulated. What was needed was a well-organized knowledge of the mathematical structures of investment, production, distribution, and consumption.

To make a short story of it all, it was discovered that an economy obeyed the same laws as electricity and that all of the mathematical theory and practical and computer know-how developed for the electronic field could be directly applied in the study of economics. This discovery was not openly declared, and its more subtle implications are kept a closely guarded secret, for example that in an economic model, human life is measured in dollars, and that the electric spark generated when opening a switch connected to an active inductor is mathemati-

cally analogous to the initiation of war.

The greatest hurdle that theoretical economists faced was the accurate description of the household as an industry. This is a challenge because consumer purchases are a matter of choice which in turn is influenced by income, price, and other economic factors.

This hurdle was cleared in an indirect and statistically approximate way by an application of shock testing to determine the current characteristics, called current technical coefficients, of a household industry.

Finally, because problems in theoretical electronics can be translated very easily into problems of theoretical economics, and the solution translated back again, it follows that only a book of language translation and concept definition needed to be written for economics. The remainder could be gotten from standard works on mathematics and electronics. This makes the publication of books on advanced economics unnecessary, and greatly simplifies project security.

Industrial Diagrams. An ideal industry is defined as a device which receives value from other industries in several forms and converts them into one specific product for sales and distribution to other industries. It has several inputs and one output. What the public normally thinks of as one industry is really an industrial complex, where several industries under one roof produce one or more products.

A pure (single output) industry can be represented oversimply by a circuit block. See Figure 1.

The flow of product from industry #1 (supply) to industry #2 (demand) is denoted by I_{12} . The total flow out of industry "K" is denoted by I_k (sales, etc.). A three industry network can be diagrammed. See Figure 2.

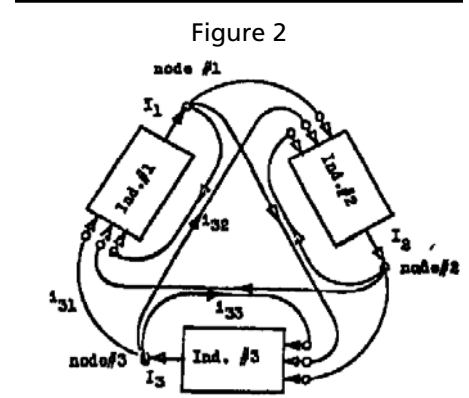
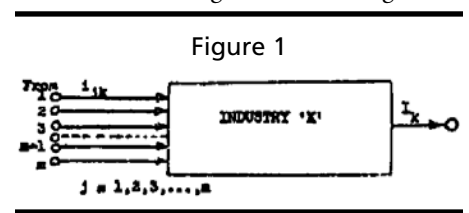

Figure 3

$$\begin{aligned} \text{Node \#1 : } I_1 &= i_{11} + i_{12} + i_{13} = \sum_{k=1}^3 i_{1k} \\ \text{Node \#2 : } I_2 &= i_{21} + i_{22} + i_{23} = \sum_{k=1}^3 i_{2k} \\ \text{Node \#3 : } I_3 &= i_{31} + i_{32} + i_{33} = \sum_{k=1}^3 i_{3k} \end{aligned}$$

where \sum denotes $\sum_{k=1}^{k=3}$

A node is a symbol of collection and distribution of flow. Node #3 receives from industry #3 and distributes to industries #1 and #3. If industry #3 manufactures chairs, then a flow from industry #3 back to industry #3 simply indicates that industry #3 is using part of its own output product, for example, as office furniture. Therefore the flow may be summarized by the equations in Figure 3.

Three Industrial Classes

Industries fall into three categories or classes by type of output:

1. Class #1 – Capital (resources)
2. Class #2 – Goods (commodities or use – dissipative)
3. Class #3 – Services (action of population)

Class #1 industries exist at three levels: (1) Nature – sources of energy and raw materials; (2) Government – printing of currency equal to the gross national product (GNP), and extension of currency in excess of GNP; (3) Banking – loaning of money for interest, and extension (inflation/counterfeiting) of economic value through the deposit loan accounts.

Class #2 industries exist as producers of tangible or consumer (dissipated) products. This sort of activity is usually recognized and labeled by the public as “industry.”

Class #3 industries are those which have service rather than a tangible product as their output. These industries are called (1) households, and (2) governments.

Their output is human activity of a mechanical sort, and their basis is population.

Aggregation. The whole economic system can be represented by a three-industry model if one allows the names of the outputs to be (1) capital, (2) goods, and (3) services. The problem with this representation is that it would not show the influence, say, the textile industry on the ferrous metal industry. This is because both the textile industry and the ferrous metal industry would be contained within a single classification called the “goods industry” and by this process of combining or aggregating these two industries under one system block they would lose their economic individuality.

The E-Model. A national economy consists of simultaneous flows of production, distribution, consumption, and investment. If all of these elements including labor and human functions are assigned a numerical value in like units of measure, say, 1939 dollars, then this flow can be further represented by a current flow in an electronic circuit, and its behavior can be predicted and manipulated with useful precision.

The three ideal passive energy components of electronics, the capacitor, the resistor, and the inductor correspond to the three ideal passive energy components of economics called the pure industries of capital, goods, and services, respectively.

- Economic capacitance represents the storage of capital in one form or another.
- Economic conductance represents the level of conductance of materials for the production of goods.
- Economic inductance represents the inertia of economic value in motion. This is a population phenomenon known as services.

Economic Inductance. An electrical inductor (e.g., a coil or wire) has an electric current as its primary phenomenon and a magnetic field as its secondary phenomenon (inertia). Corresponding to this, an economic inductor has a flow of economic value as its primary phenomenon and a population field as its secondary field phenomenon of inertia. When the flow of economic value (e.g., money) diminishes, the human population field collapses to keep the economic value (money) flowing (extreme case – war).

This public inertia is a result of consumer buying habits, expected standard of living, etc., and is generally a phenomenon of self-preservation.

Inductive Factors to Consider:

1. Population
2. Magnitude of the economic activities of the government
3. The method of financing these government activities (See Peter-Paul Principle – inflation of the currency.)

Translation (a few examples will be given):

- Charge: coulombs; dollars (1939).
- Flow/Current: amperes (coulombs per second); dollars of flow per year.
- Motivating Force: volts; dollars (output) demand.
- Conductance: amperes per volt; dollars of flow per year per dollar demand.
- Capacitance: coulombs per volt; dollars of production inventory/stock per dollar

demand.

Time Flow Relationships and Self-Destructive Oscillations. An ideal industry may be symbolized electronically in various ways. The simplest way is to represent a demand by a voltage and a supply by a current. When this is done, the relationship between the two becomes what is called an admittance, which can result from three economic factors: (1) foresight flow, (2) present flow, and (3) hindsight flow.

1. *Foresight flow* is the result of that property of living entities to cause energy (food) to be stored for a period of low energy (e.g., a winter season). It consists of demands made upon an economic system for that period of low energy (winter season).

In a production industry it takes several forms, one of which is known as production stock or inventory. In electronic symbology this specific industry demand (a pure capital industry) is represented by capacitance and the stock or resource is represented by a stored charge. Satisfaction of an industry demand suffers a lag because of the loading effect of inventory priorities.

2. Present flow ideally involves no delays. It is, so to speak, input today for output today, a “hand to mouth” flow. In electronic symbology, this specific industry demand (a pure us industry) is represented by a conductance which is then a simple economic valve (a dissipative element).

3. Hindsight flow is known as habit or inertia. In electronics this phenomenon is the characteristic of an inductor (economic analog = a pure service industry) in which a current flow (economic analog = flow of money) creates a magnetic field (economic analog = active human population) which, if the current (money flow) begins to diminish, collapse (war) to maintain the current (flow of money energy). Other large alternatives to war as economic inductors or economic flywheels are an open-ended social welfare program, or an enormous (but fruitful) open-ended space program.

The problem with stabilizing the economic system is that there is too much demand on account of (1) too much greed and (2) too much population. This creates excessive economic inductance which can only be balanced with economic capacitance (true resources or value – e.g., in goods or services). The social welfare program is nothing more than an open-ended credit balance system which creates a false capital industry to give nonproductive people a roof over their heads and food in their stomachs. This can be useful, however, because the recipi-

ents become state property in return for the “gift,” a standing army for the elite. For he who pays the piper picks the tune.

Those who get hooked on the economic drug, must go to the elite for a fix. In this, the method of introducing large amounts of stabilizing capacitance is by borrowing on the future “credit” of the world. This is a fourth law of motion onset, and consists of performing an action and leaving the system before the reflected reaction returns to the point of action – a delayed reaction. The means of surviving the reaction is by changing the system before the reaction can return. By this means, politicians become more popular in their own time and the public pays later. In fact, the measure of such a politician is the delay time.

The same thing is achieved by a government by printing money beyond the limit of the gross national product, and economic process called inflation. This puts a large quantity of money into the hands of the public and maintains a balance against

their greed, creates a false self-confidence in them and, for a while, stays the wolf from the door.

They must eventually resort to war to balance the account, because war ultimately is merely the act of destroying the creditor, and the politicians are the publicly hired hit men that justify the act to keep the responsibility and blood off the public conscience. (See section on consent factors and social-economic structuring.)

If the people really cared about their fellow man, they would control their appetites (greed, procreation, etc.) so that they would not have to operate on credit or welfare social system which steals from the worker to satisfy the bum. Since most of the general public will not exercise restraint, there are only two alternatives to reduce the economic inductance of the system.

1. Let the populace bludgeon each other to death in war, which will only result in a total destruction of the living earth.

2. Take control of the world by the use of economic “silent weapons” in a form of “quiet warfare” and reduce the economic inductance of the world to a safe level by a process of benevolent slavery and genocide.

The latter option has been taken as the obviously better one. At this point it should be crystal clear to the reader why absolute secrecy about the silent weapons is necessary. The general public refuses to improve its own mentality and its faith in its fellow man. It has become a herd of proliferating barbarians, and, so to speak, a blight upon the face of the earth.

They do not care enough about economic science to learn why they have not been able to avoid war despite religious morality. And their religious or self-gratifying refusal to deal with earthly problems renders their solution and their reach.

It is left to those few who are truly willing

to think and survive as the fittest to solve the problem for themselves as the few who really care.

Otherwise, exposure of the silent weapon would destroy our only hope of preserving the seed of the future true humanity.

Industry Equivalent Circuits. The industry “Q” can be given a block symbol as in Figure 4.

Terminals #1 through #m are connected directly to the outputs of industries #1 and #m, respectively.

The equivalent circuit of Industry Q is given in Figure 5.

Characteristics:

- All inputs are at zero volts.
- A – Amplifier – causes output current I_Q to be represented by a voltage E_Q .
- Amplifier delivers sufficient current at E_Q to drive all loads Y_{10} through Y_{mQ} and sink all currents i_{1Q} through i_{mQ} .

The unit tranconductance amplifier A_Q is constructed is described in Figure 6. The arrow denotes the direction of flow of capital, goods and services. The total demand is given as E_Q , where $E_Q = I_Q$. See Figure 7 (* – to other industries).

The coupling network Y_{PQ} symbolizes the demand which industry Q makes on industry P. The connective admittance Y_{PQ} is called the “technical coefficient” of the industry Q stating the demand of industry Q, called the industry of use, for the output in capital, goods, or services of industry P called the industry of origin.

The flow of commodities from industry P to industry Q is given by i_{PQ} evaluated by the formula:

$$i_{PQ} = Y_{PQ} * E_Q$$

When the admittance Y_{PQ} is a simple conductance, this formula takes on the common appearance of Ohm’s Law,

$$i_{PQ} = g_{PQ} * I_Q$$

The interconnection of a three industry system can be diagrammed as follows. The blocks of the industry diagram can be opened up revealing the technical coefficients, and a much simpler format. The equations of flow are given in Figure 8.

To be continued.

Our Comment

Congress is more likely to heed the demands for elementary needs where the absence of contact with such needs of the non-initiated is likely to bring on less manageable screeching about its own operations. It knew in a trial market what was within its control and what was not, and proceeded accordingly. W.K.

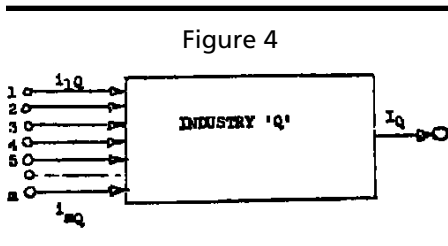

Figure 4

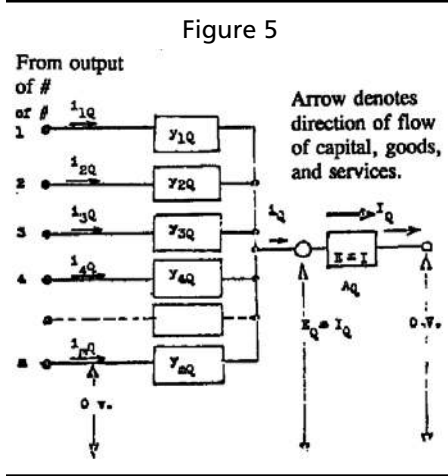

Figure 5

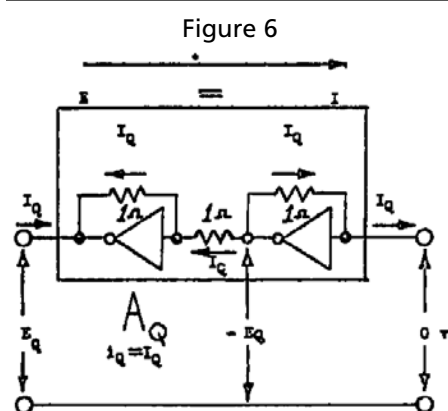

Figure 6

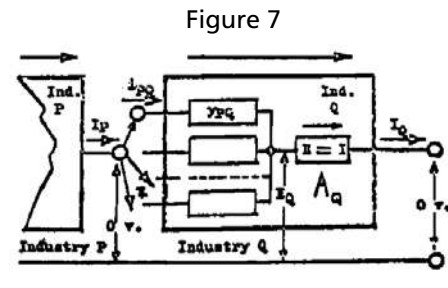

Figure 7

$$I_1 = i_{11} + i_{12} + i_{13} + i_{10} = \sum i_{1k} + i_{10}$$

$$I_2 = i_{21} + i_{22} + i_{23} + i_{20} = \sum i_{2k} + i_{20}$$

$$I_3 = i_{31} + i_{32} + i_{33} + i_{30} = \sum i_{3k} + i_{30}$$

Figure 8

Look In Your Mirror

By Thomas L. Friedman *The New York Times*, September 19, 2012

On Monday, David D. Kirkpatrick, the Cairo bureau chief for the *Times*, quoted one of the Egyptian demonstrators outside the American Embassy, Khaled Ali, as justifying last week's violent protests by declaring: "We never insult any prophet – not Moses, not Jesus – so why can't we demand that Muhammad be respected?" Mr. Ali, a 39-year-old textile worker, was holding up a handwritten sign in English that read: "Shut Up America." "Obama is the president, so he should have to apologize!"

I read several such comments from the rioters in the press last week, and I have big problem with them. I don't like to see anyone's faith insulted, but we need to make two things very clear – more clear than President Obama's team has made them. One is that an insult – even one as stupid and ugly as the anti-Islam video on YouTube that started all of this – does not entitle people to go out and attack embassies and kill innocent diplomats. That is not how a proper self-governing people behave. There is no excuse for it. It is shameful. And, second, before demanding an apology from our president, Mr. Ali and the young Egyptians, Tunisians, Libyans, Yemenis, Pakistanis, Afghans and Sudanese who have been taking to the streets might want to look in the mirror – or just turn on their own televisions. They might want to look at the chauvinistic bile that is pumped out by some of their own media – on satellite television stations and Web sites or sold in sidewalk bookstores outside of mosques – insulting Shiites, Jews, Christians, Sufis and anyone else who is not a Sunni, or fundamentalist, Muslim. There are people in their countries for whom

hating "the other" has become a source of identity and a collective excuse for failing to realize their own potential.

The Middle East Media Research Institute, or Memri, was founded in 1998 in Washington, by Yigal Carmon, a former Israeli government adviser on counter-terrorism, "to bridge the language gap between the Middle East and the West by monitoring, translating and studying Arab, Iranian, Urdu and Pashtu media, schoolbooks, and religious sermons." What I respect about Memri is that it translates not only the ugly stuff but the courageous liberal, reformist Arab commentators as well. I asked Memri for a sampler of the hate-filled videos that appear regularly on Arab/Muslim mass media. Here are some:

On Christians:

Hasan Rahimpur Azghadi of the Iranian Supreme Council for Cultural Revolution: Christianity is "a reeking corpse, on which you have to constantly pour eau de cologne and perfume, and wash it in order to keep it clean." www.memritv.org/clip/en/1528.htm – July 20, 2007.

Sheik Al-Khatib al-Baghdadi: it is permissible to spill the blood of the Iraqi Christians – and a duty to wage jihad against them. www.memri.org/report/en/0/0/0/0/0/5200.htm – April 14, 2011.

Abd al-Aziz Fawzan al-Fawzan, a Saudi professor of Islamic law, calls for "positive hatred" of Christians. Al-Majd TV (Saudi Arabia) www.memritv.org/clip/en/992.htm – December 16, 2005.

On Shiites:

The Egyptian Cleric Muhammad Hussein Yaaqub: "Muslim Brotherhood Presidential Candidate Mohamed Morsi told me that the Shiites are more dangerous to

Islam than the Jews." www.memritv.org/clip/en/3466.htm – June 13, 2012

The Egyptian Cleric Mazen al-Sirsawi: "If Allah had not created the Shiites as human beings, they would have been donkeys" www.memritv.org/clip/en/3101.htm – August 7, 2011.

The Sipah-e-Sahaba Pakistan video series: "The Shiite is a Nasl [Race/Offspring] of Jews." www.memri.org/report/en/0/0/0/0/0/51/6208.htm – March 21, 2012.

On Jews:

Article on the Muslim Brotherhoods Web site praised jihad against America and the Jews: "The Descendants of Apes and Pigs." www.memri.org/report/en/0/0/0/0/0/51/6656.htm – September 7, 2012.

The Pakistani cleric Muhammad Raza Sqib Mustafai: "When the Jews are wiped out, the world would be purified and the sun of peace would rise on the entire world." www.memri.org/report/en/0/0/0/0/0/51/6557.htm – August 1, 2012.

Dr. Ismail Ali Muhammad, a senior Al-Azhar scholar: The Jews, "a source of evil and harm in all human societies." www.momri.org/report/en/0/0/0/0/0/51/6086.htm – February 14, 2012.

On Sufis:

A shrine venerating a Sufi Muslim saint in Libya has been partly destroyed, the latest in a series of attacks blamed on ultraconservative Salafi Islamists. www.bbc.co.uk/news/world-africa-19380083 – August 26, 2012.

As a Jew who has lived and worked in the Muslim world, I know that these expressions of intolerance are only one side of the story and that there are deeply tolerant views and strains of Islam espoused and practiced there as well. Theirs are complex societies.

That's the point. America is a complex society, too. But let's cut the nonsense that this is just *our* problem and the only issue is how *we* clean up *our* act. That Cairo protester is right: We should respect the faiths and prophets of others. But that runs both ways. Our president and major newspapers consistently condemn hate speech against other religions. How about yours?



Our Comment. So long as the great heritage of classical Greece remains suppressed in contemporary Greece herself, we are flying essentially self-blinded. *W.K.*